

2017

2019 10

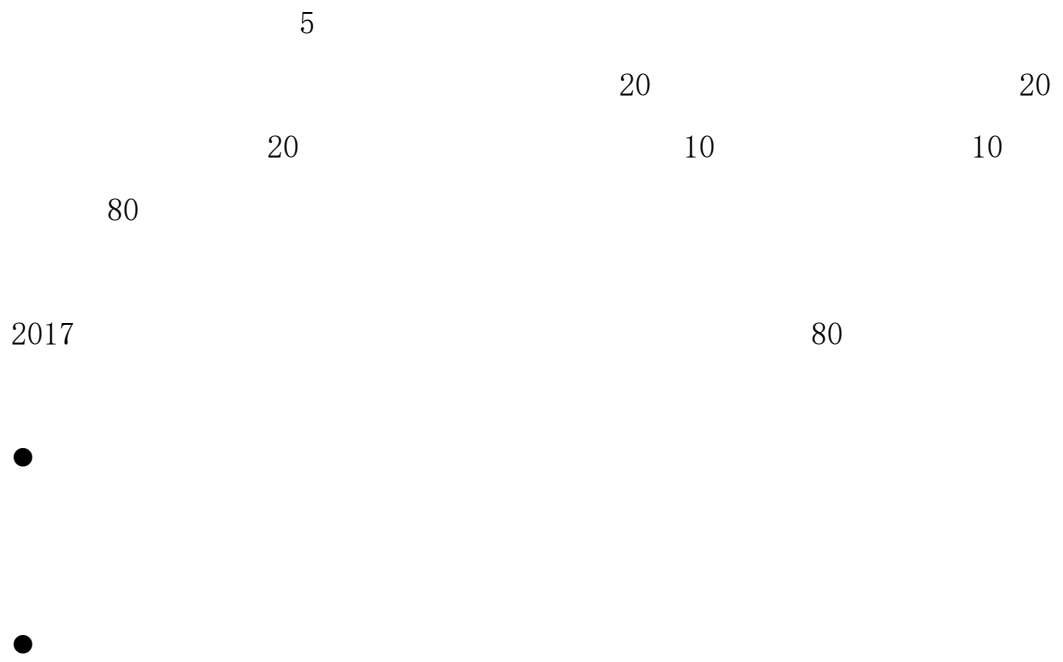

		1
		1
1.	1-1	1
2.	1-2	6
3.	1-3	11
4.	1-4	16
5.	1-5	20
6.	1-6	25
7.	1-7	30
8.	1-8	35
9.	1-9	40
10.	1-10	45
11.	1-11	50
12.	1-12	53
13.	1-13	56
14.	1-14	59
15.	1-15	62
16.	1-16	65
17.	1-17	68
18.	1-18	71
19.	1-19	74
20.	1-20	77
		80
		80
1.	2-1	80
2.	2-2	83
3.	2-3	85
4.	2-4	87
5.	2-5	89
6.	2-6	91
7.	2-7	93

8.	2-8	95
9.	2-9	98
10.	2-10	101
11.	2-11	104
12.	2-12	107
13.	2-13	110
14.	2-14	113
15.	2-15	116
16.	2-16	119
17.	2-17	122
18.	2-18	126
19.	2-19	130
20.	2-20	133
		136
1.	3-1	136
2.	3-2	140
3.	3-3	145
4.	3-4	149
5.	3-5	154
6.	3-6	159
7.	3-7	164
8.	3-8	169
9.	3-9	174
10.	3-10	179
11.	3-11	184
12.	3-12	186
13.	3-13	188
14.	3-14	190
15.	3-15	192
16.	3-16	194
17.	3-17	196
18.	3-18	198
19.	3-19	200
20.	3-20	202

		204
		204
1.	4-1	204
2.	4-2	207
3.	4-3	210
4.	4-4	213
5.	4-5	216
6.	4-6	219
7.	4-7	222
8.	4-8	225
9.	4-9	228
10.	4-10	231
		234
1.	5-1	234
2.	5-2	236
3.	5-3	238
4.	5-4	240
5.	5-5	242
6.	5-6	244
7.	5-7	246
8.	5-8	248
9.	5-9	250
10.	5-10	252

1. 1-1

1

33 2100 10 2010  
310 1995

1

3 5

1.2

1.2

2003

ABC

1

1

2

4

4

2

3

7

\*\*\*

3

10

10

2000

1-1

10		10	6S 0/3/5			
		0/3/5				
90	20			16-20		
				11-15		
				6-10		
				1-5		
				0		
	9			8-9		
				6-7		
				4-5		
				0-3		
		21		/	21	



			/	18	
			/	15	
			/	12	
			/	9	
			/	6	
			/	3	
				0	
		20	15		

			0/3/5	
		20	5                      5	
			6                                      4	
	100			

-

2. 1-2

1

2002

0-16

1

:// . .

4

2

3

3

7

\*\*\*

4

10

200

500

120

5

		( )	10%	(
	20%	800		80
	30%	112		11.2
	50%	88		8.8

A.

?

B.

2

7 8

0 2010

3

60

4

1-2

1-2

10		10	6S 0/3/5		
		0/3/5			
90	20			16-20	
				11-15	
				6-10	
				1-5	
				0	
	9			8-9	
				6-7	
				4-5	
				0-3	
		21	/	21	

			/	18	
			/	15	
			/	12	
			/	9	
			/	6	
			/	3	
				0	
		20	15		

			0/3/5	
		20	5                      5	
			6                                      4	
	100			

3. 1-3

1

14

4

DSR

1

14

://

34091294.

. /

14

4

2

14

14

3

70

14

7

\*\*\*

4

14

20

500

14

1500

14

350

5

14

		( )	10%	(
	20%	40000		4000
	30%	8000		800
	50%	2000		200

A.

?

B.

2



7 8

0 2010

3

60

4

1-3

1-3

6S

0/3/5

10

10

			/	18	
			/	15	
			/	12	
			/	9	
			/	6	
			/	3	
				0	
		20	15		

			0/3/5	
		20	5                      5	
			6                                      4	
	100			

4. 1-4

1 N F 1966

7 DSR

1 :// . .

2 4

3 3000

4 7 \*\*\*

4 20

500

1500

350

5

		( )	10% (
	20%	4000	400
	30%	800	80
	50%	200	20

- A. ?
- B.

2

7 8

0 2010

3

60

4

1-4

1-4

			6S 0/3/5		
10	10		0/3/5		
90	20			16-20	
				11-15	
				6-10	
				1-5	
				0	
	9				8-9
					6-7
					4-5
					0-3
	21		/		21
			/		18
			/		15

			/	12	
			/	9	
			/	6	
			/	3	
				0	
			15		
		20			
			0/3/5		
			5	5	
		20	6	4	
	100				



5. 1-5

1

200

DSR

1

:// 71054329. /

4

2

3

7

\*\*\*

4

30

5

2

20

15

5

		( )	10%	(
	20%	400		40
	30%	80		8
	50%	20		2

A.

?

B.

2

7 8

0 2010

3

60

4

1-5

1-5

				6S 0/3/5		
	10	10				
			0/3/5			
90		20		16-20		
				11-15		
				6-10		
				1-5		
				0		
		9		8-9		
				6-7		
				4-5		
				0-3		
		21		/	21	

			/	18	
			/	15	
			/	12	
			/	9	
			/	6	
			/	3	
				0	
		20	15		

			0/3/5	
		20	5                      5	
			6                                      4	
	100			

6. 1-6

1

DSR

1

:// 36830724. . /

4

2

3

7

\*\*\*

4

30

50

2

100

40

5

		( )	10%	(
	20%	400		40
	30%	80		8
	50%	20		2

A.

?

B.

2

7 8

0 2010

3

60

4

1-6

1-6

10		10	6S 0/3/5		
		0/3/5			
90		20		16-20	
				11-15	
				6-10	
				1-5	
				0	
		9		8-9	
				6-7	
				4-5	
				0-3	
		21	/	21	



			/	18	
			/	15	
			/	12	
			/	9	
			/	6	
			/	3	
				0	
		20	15		

			0/3/5	
		20	5                      5	
			6                                      4	
	100			

7. 1-7

1

DSR

1

:// . . /

4

2

3

R D

7

\*\*\*

4

50

60

2

80

40

5

		( )	10%	(
	20%	400		40
	30%	80		8
	50%	20		2

A.

?

B.

2

7 8

0 2010

3

60

4

1-7

1-7

				6S 0/3/5		
	10	10				
			0/3/5			
90		20		16-20		
				11-15		
				6-10		
				1-5		
				0		
		9		8-9		
				6-7		
				4-5		
				0-3		
		21		/	21	

			/	18	
			/	15	
			/	12	
			/	9	
			/	6	
			/	3	
				0	
		20	15		

			0/3/5	
		20	5                      5	
			6                                      4	
	100			

8. 1-8

1

4

DSR

1

://

.

.

/

4

2

3

4 6+128G

7

\*\*\*

4

10

50

1

2000

1200

5

		( )	10%	(
	20%	8000		800
	30%	1500		150
	50%	500		50

A.

?

B.



2

7 8

0 2010

3

60

4

1-8

1-8

10		10	6S 0/3/5		
		0/3/5			
90		20		16-20	
				11-15	
				6-10	
				1-5	
				0	
		9		8-9	
				6-7	
				4-5	
				0-3	
		21	/	21	

			/	18	
			/	15	
			/	12	
			/	9	
			/	6	
			/	3	
				0	
		20	15		

			0/3/5	
		20	5                      5	
			6                                      4	
	100			

9. 1-9

1

3

DSR

1

:// . . /

4

2

3

5-6

7

\*\*\*

4

20

40

3

50

35

5

		( )	10%	(
	20%	400		40
	30%	80		8
	50%	20		2

A.

B.



1-9

				6S 0/3/5		
	10	10				
			0/3/5			
90		20		16-20		
				11-15		
				6-10		
				1-5		
				0		
		9		8-9		
				6-7		
				4-5		
				0-3		
		21		/	21	

			/	18	
			/	15	
			/	12	
			/	9	
			/	6	
			/	3	
				0	
		20	15		



			0/3/5	
		20	5                      5	
			6                                      4	
	100			

10. 1-10

1

5

DSR

1

:// . . /

4

2

3

H -704B

7

\*\*\*

4

5

50

1

200

50

5

		( )	10%	(
	20%	4000		400
	30%	800		80
	50%	200		20

A. ?

2

7 8

0 2010

3

60

4

1-10

1-10

10		10	6S 0/3/5			
		0/3/5				
90	20			16-20		
				11-15		
				6-10		
				1-5		
				0		
	9			8-9		
				6-7		
				4-5		
				0-3		
		21		/	21	

			/	18	
			/	15	
			/	12	
			/	9	
			/	6	
			/	3	
				0	
		20	15		

			0/3/5	
		20	5                      5	
			6                                      4	
	100			

11.

1-11

1

2

1	
1	
2	
2	
3	
3	
4	
4	
5	
5	

3

3

200

3

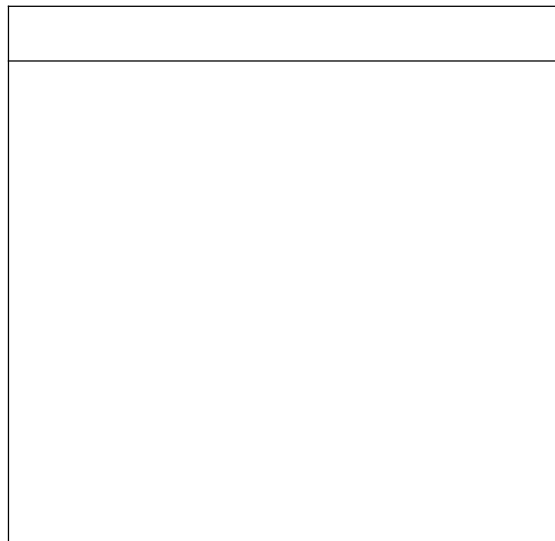

2

7 8 0 2010

3

60

4

1-11



10	10	6S	0/3/5
			0/3/5
90	25	5	
		16-20	
	35	11-15	
		6-10	
30	0-5		
	29-35		
	22-28		
		15-21	
		8-14	
		0-7	
		0/3/5	
		18-25	
		10-17	
		0-9	
		100	

12. 1-12

1

GSM TD-SCDMA 2000 4 20  
518  
2011  
500 87  
50

30 15  
15

1

1 40  
1

2

:  
7 21 30 15  
11 12  
11 12  
11 12

2

2

1	
1	
2	

2	
3	
3	
4	
4	
5	
5	

3

3

200

3

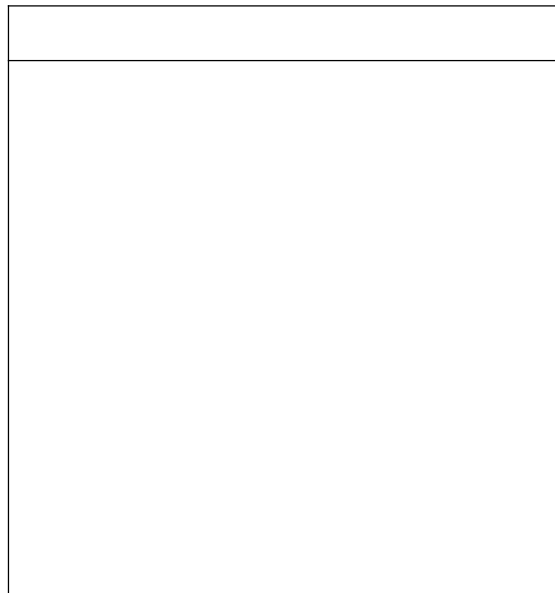

2

7 8

0 2010

3

60

4

1-12

1-12

6S

0/3/5

10

10

13. 1-13

1

:// . . /

200

800

6 11

6 6

20

6 10

1145

6 8

6

8

6 10

6 8

1145

1

1

40

1

2

:

6 8

6 10

2

2

1	
1	
2	
2	
3	
3	
4	
4	
5	
5	

3

3

200

3

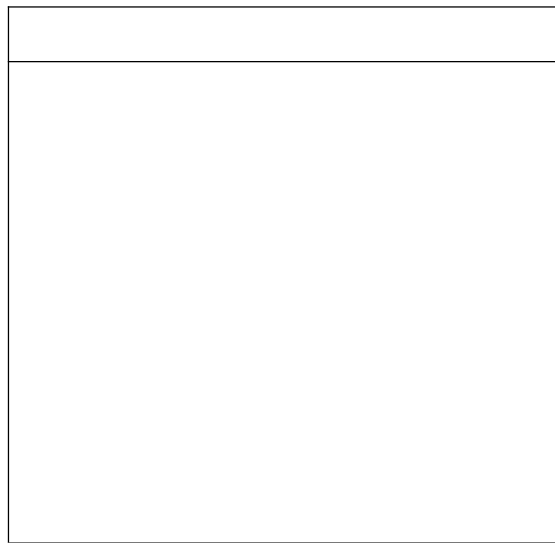

2

7 8

0 2010

3

60

4

1-13

1-13

10	10	6S	0/3/5
			0/3/5
90	25	5	
		16-20	
		11-15	
		6-10	
		0-5	
90	35	29-35	
		22-28	
		15-21	
		8-14	
		0-7	
		0/3/5	
90	30	18-25	
		10-17	
		0-9	
		100	

14. 1-14

1

4

5 2

5 6

1

1

40

1

2

:

2

2

1	
1	
2	
2	
3	
3	
4	
4	



5	
5	

3

3

200

3

2

7 8

0 2010

3

60

4

1-14

10	10	6S	0/3/5
			0/3/5
90	25	5	
		16-20	
	35	11-15	
		6-10	
30	0-5		
	29-35		
	22-28		
	15-21		
		8-14	
		0-7	
		0/3/5	
		18-25	
		10-17	
		0-9	
		100	

15. 1-15

1

2015 3 17

198

32G U 3 19

U

U

1G

32G

1

1

40

1

2

U

32G U

1G

2

2

1	
1	
2	
2	
3	
3	
4	
4	
5	
5	

3

3

200

3

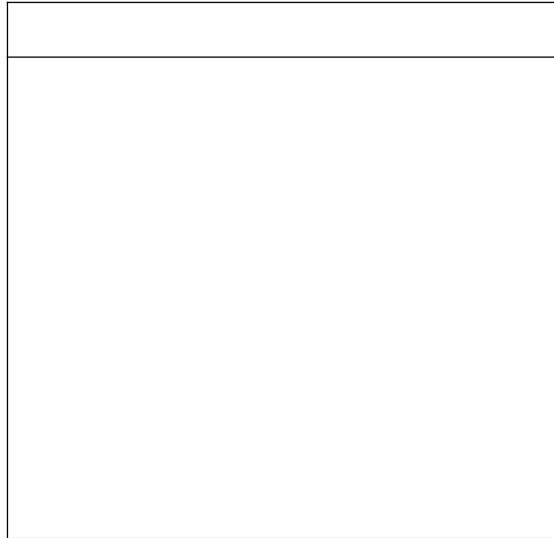

2

7

8

0

2010

3

60

4

1-15

1-15

6S

0/3/5

10

10

16. 1-16

1

( :// . . . /)

5

2018 2 6

200

2

1

1

40

1

2

2

2

2

1	
1	
2	
2	
3	
3	
4	

4	
5	
5	

3

3

200

3

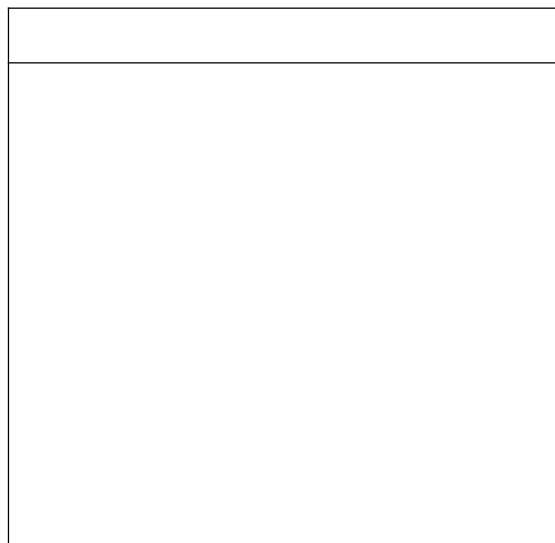

2

7

8

0

2010

3

60

4

1-16

1-16

10	10	6S	0/3/5
			0/3/5
90	25	5	
		16-20	
	35	11-15	
		6-10	
30	0-5		
	29-35		
	22-28		
	15-21		
		8-14	
		0-7	
		0/3/5	
		18-25	
		10-17	
		0-9	
		100	



17. 1-17

1

B2C

+

199 /

4

4

199

1

1

40

1

2

2

2

1	
1	
2	
2	
3	
3	
4	
4	

5	
5	

3

3

200

3

2

7

8

0

2010

3

60

4

1-17

10	10	6S	0/3/5
			0/3/5
90	25	5	
		16-20	
	35	11-15	
		6-10	
30	0-5		
	29-35		
	22-28		
	15-21		
		8-14	
		0-7	
		0/3/5	
		18-25	
		10-17	
		0-9	
		100	

18. 1-18

1

1999

17

25000

2003 12

9000

2015 10 26

2015 12 15

2015 12 25

28445467318

(12

25 )

( )

1

1

40

1

2

12 25

2

2

1	
1	
2	
2	
3	
3	
4	
4	
5	
5	

3

3

200

3

2

7

8

0

2010

3

60

4

1-18

10	10	6S	0/3/5
			0/3/5
90	25	5	
		16-20	
	35	11-15	
		6-10	
30	0-5		
	29-35		
	22-28		
	15-21		
		8-14	
		0-7	
		0/3/5	
		18-25	
		10-17	
		0-9	
		100	

19.

1-19

1

100%

150

1000

1

1

40

1

2

150

1

1000

2

2

1	
---	--

1	
2	
2	
3	
3	
4	
4	
5	
5	

3

3

200

3

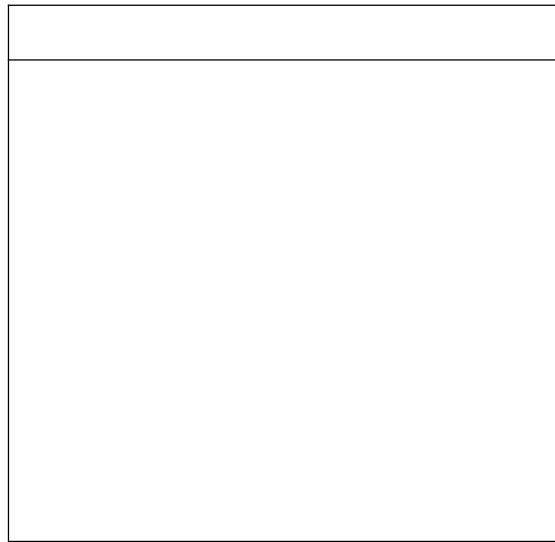

2

7 8

0 2010

3

60

4

1-19



1-19

10	10	6S	0/3/5
			0/3/5
	25	5	
		16-20	
90	35	11-15	
		6-10	
		0-5	
	35	29-35	
		22-28	
		15-21	
		8-14	
		0-7	
		0/3/5	
	30	18-25	
		10-17	
		0-9	
		100	

20. 1-20

1

:// . . / 2014 4

0 12

APP 2019 3 2

150

1

1

40

1

2

2016 3 2

150

2

2

1	
---	--

1	
2	
2	
3	
3	
4	
4	
5	
5	

3

3

200

3

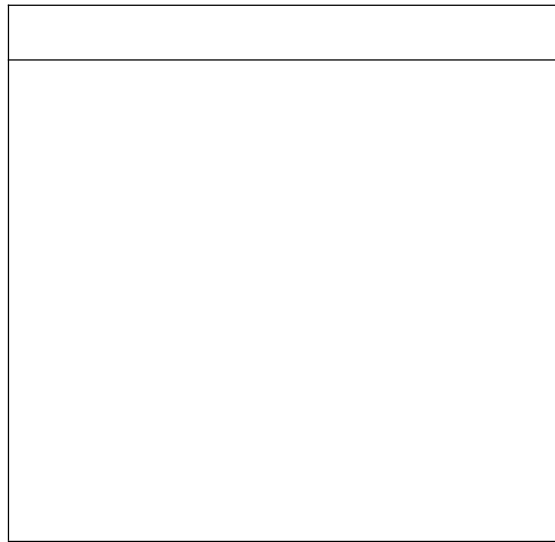

2

7

8

0

2010

3

60

4

1-20

1-20

10	10	6S	0/3/5
			0/3/5
	25	5	
		16-20	
90	35	11-15	
		6-10	
		0-5	
	35	29-35	
		22-28	
		15-21	
		8-14	
		0-7	
		0/3/5	
	30	18-25	
		10-17	
		0-9	
		100	

1. 2-1

1  
B N

58 /

950 400

. . . 1.  
2. 3.

1

. . .

100KB

2

P 7 8 0 20010  
3 CS6.0  
4 60  
( 2-1)



2. 2-2

1

1860 /

3

150

30

50

6

1

950

350

.

.

1.

2.

3.

1

.

.

.

100KB

2

7 8

0 2010

P

CS6.0

3

60

4

( 2-2)



(2-2)

(10 )	10	5	6S PSD
	5	3	2
	10	5	5
	20	10	5
	25	5	5
(90 )	10	5	3
	10	5	3
	5	1	2
	5	2	2
	100		

3.

2-3

1

950

400

1

100KB

2

7 8

0 2010

P

CS6.0

3

60

4

( 2-3)

(2-3)

4. 2-4

1

+

950 350

1.

2.

1

100KB

2

7 8

0 2010

P

CS6.0

3

60

4

( 2-4)

(2-4)

(10 )	10	5	6S PSD
	5	3	2
	10	5	5
	20	10	5
	25	5	5
(90 )	10	5	3
	10	5	3
	5	1	2
	5	2	2
	100		

5. 2-5

1

790

72 /

/

3

3

.PSD

.JPG

2

7 8

0 2010

P

CS6.0

3

60

4

( 2-5)

(2-5)

6S

(10 )

10

5

PSD

5

15

3

4

3 /

12

(90  
)





(2-6)

(10 )	10	5 6S PSD	5
(90 )	15	3 4	3 /
	12		3 /
	15	1 0-5 2 2 6-10 3 3	3 3 3 11-15
	10	5	3 2
	15		5 5 5
	8	4	0 /2 /3 /4 /5 4
	5		0 /2 /3 /4 /5
	10		2 6
		100	2



2-7

(10 )	10	5 6S PSD	5
(90 )	15	3 4	3 /
	12		3 /
	15	1 0-5 2 2 6-10 3 3	3 3 3 11-15
	10	5	3 2
	15		5 5 0 /2 /3 /4 /5
	8	4	4
	5		0 /2 /3 /4 /5
	10		2 6
		100	2

8. 2-8

1

L B

1) L

80 80 80 /

L .PSD

.JPG

JPG

150K

2) B

1920 500 100 /

1. 2 .

B

B

B

L

.PSD

.JPG

JPG

150K

3)

2

800 800 72 /

\* \*

1. 2.

3M

2

7 8 0 2010

P

CS6.0

3

60

4

( 2-8)

(2-8)

6S

5

(10 )

10

PSD

L

18

5

4

2

2

10

5

5

4

2

2

B

30

4

2

2

8

5

(90  
)



01

4

9. 2-9

1

SK-II

L B  
1) L

80 80 80 /

.JPG .PSD  
150K JPG

2) B

1920 500 100 /

B

B

B

L

.JPG  
150K

.PSD  
JPG

3)

800 2 800 72 /

\* \*

1. JPG

2. JPG

3M

2

7 8

0 2010

P

CS6.0

3

60

4

( 2-9)



(2-9)

(10 )	10	6S 5 PSD 5	5
<b>L 18</b>			
	4	2	2
	10	5	
	4	2	2
<b>B 30</b>			
	4	2	
	8	5	3
	14	B L 2 3 3	3
	4	2	2
(90 )	<b>42</b>		
	4	2	
	14	2 3 2	
		7 2 14	
	16	3 5 8 2 16	
	8	2 4 2 8	2
	100		

10. 2-10

1

L B

1) L

80 80 80 /

L

. PSD

. JPG

JPG

150K

2) B

950 120 100 /

B

B

B

L

. PSD

. JPG

JPG

150K

3)

2

800 800 72 /

\* \*

1. JPG

2. JPG

3M

2

7 8 0 2007 P  
CS6.0  
3  
4  
60  
( 2-10)

(2-10)

6S

5

(10 ) 10

PSD

2

11. 2-11

1

778

76

B

P

1

P

2

1

K



1

P

1

2

MM

K

.

U .

.

.

CSS

.

CSS

12

#CC0000

2

7 8

0 2010

P

CS6.0

D

2-11

(10 )	10	5	6S
			5
B	12	2	2
		2	4 2
	10	2	5
	10		3
			4
	8	K	2
		2	2
(90 )	10	7	3
	15	5	5
		5	
	10		4
CSS	15		5
		5	5
	100		

12. 2-12

1

1



1

1. 1. 1. 1.

1

2. 3. 4.

2. 3.

1

5. 6. 4.

5. 6. 4.

4.

. 1. 3. 4.

4.

LVSESHPIN

ISHIGAODIAN

BINFENSHIJIE



16 :// . . . . .  
: B . . . . . CSS  
1.5 : . . . . .  
K  
2  
7 8 0 2010  
P CS6.0 D CS6  
3  
60  
4  
( 2-12)

2-12

(10 )	10	5	6S
			5
B	10	L	5 5
	8	1	5
		3	
	15		3 9
			3 3
		3	
	10		2 4
			6 0
	10		4 0-6
(90 )	10		2 4
			2 5
	17	:	5 :
			5
	10	K	2
			3
		2	3
	100		

13. 2-13

1

M T

200\*120

N C S

MITING

1

L



[首页](#)

[关于我们](#)

[公司产品](#)

[联系我们](#)



新品上市



护肤系列



彩妆系列



©版权所有 米婷日化公司 [QQ交谈](#)

1

CSS

CSS

CSS

24

#990000

CSS

1

2

3

150

120

1

10



1

K

2

7 8

0 2010

P

CS6.0

D

CS6

3

60

4

( 2-13)

2-13

(10 )	10	5	6S
			5
	10	2	2
		2	2
		2	
	15	0-9	9-12
		12-15	
	16	2	2
			2
C	20		3
			3
(90 )	5		
			5
	14		3
		3	3
			3
	10	K	2
			3
		2	3
	100		

14. 2-14

1

H S D

LOGO

H S D

: . . . . . 1. 2. 3.  
 4. . . . . 12  
 173 404

1. 1. 1.  
 1. 1. 1.

1.

1 4

2. 3.

#FF4615

#0887DE

#FDE52A

#B9EE13



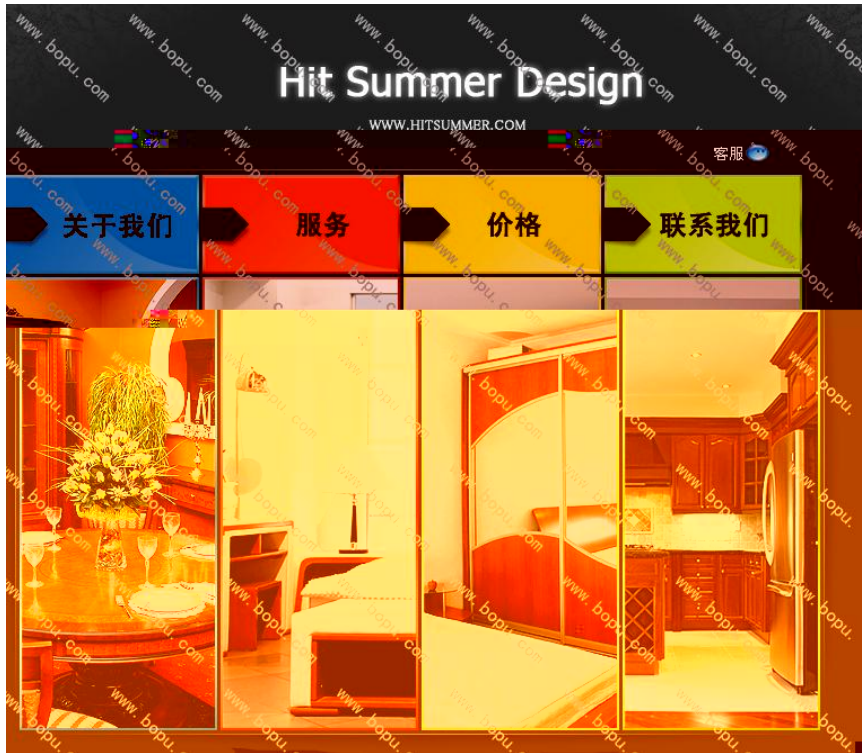

1

K

:// . . /

:// . . /      :// . . .  
:// . . /

2

7 8 0 2010

P CS6.0 D CS6

3

60

4

( 2-14)

2-14

(10 )	10	5	6S
			5
L	6	LOGO	0-2 /3-4 /5-6 H S D 0
	12	1	
	18	2	2
	20	0-1 /2-3 /4	4
(90 )	14	0-10	2 2
	4	2	2
	8	K	2 2
	8	2	2
	8		2
	100		



15. 2-15

1

1

1.

2.

.

.

.

.

700

230



1

1

1.

4.

1

2

#FF0000

#FFFFFF

3

4

1

.

#CCCCCC

K

1.

:// . . /

2

7

8

0

2010

P

CS6.0

D

CS6

3

60

4

( 2-15)

2-15

(10 )	10	5	6S
			5
B	16	2	0 /1-3 /4-5 0/1-3/4-5
			2 0-2 /3-4
	20	1	4 2 0 /1 1 2
	29		0-15 2 2 12
(90 )	6	2	2 2
	10		K 2 3 2 3
	9		5 2
	100		

16.

2-16

1

800      200      B      1.

·      ·

·

· G      -II.

·

1.      2.

1.

·      B      1

1

3 J      4 J

1.      2.      3.      4.

198      70

<      =”      ”><      =”      ”></      >

1

K



[网站首页](#) | 
 [旅游度假](#) | 
 [放眼世界](#) | 
 [各地风光](#) | 
 [环球资讯](#) | 
 [天气](#)

[旅游度假](#)  
[放眼世界](#)  
[各地风光](#)  
[环球资讯](#)  
[联系我们](#)



[西安国旅](#) 网店在线客服 029-86601153 | 
 [中国旅游网](#) | 
 [昆明康辉国旅总部](#) 在线咨询 | 
 [西藏中青旅](#) 00-0891

版权所有©环球旅游资讯网 2019-2022年

1

2

3

4

60

7 8 0 2010

P CS6.0 D CS6

( 2-16)

2-16

(10 )	10	6S 0 /3 /5  0 /3  /5	
(9 0 )	15	LOGO 2  3 B 2  2 3	
	10	2 2 4 2	
	20	5 10 1	
	7	3 4	
	20	2 2 5 0-5	
	8	3 5	
	10	K 3 2 3	2
	100		

17. 2-17

1

SKINFOOD

01.

LOGO

SKINFOOD

A

24

-45

10

01

04.

04

-2.

400

350

01

04

01.

04.

-2.

1

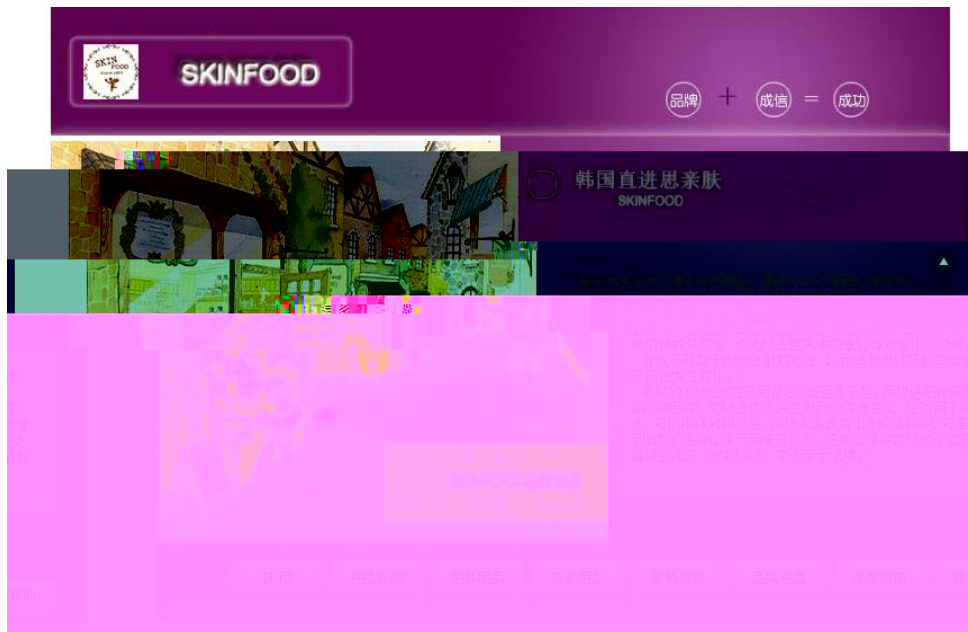

1

3.

3.

1000

540

2

1.

2.

490

450

2.

1.

2.

2

DIV

1.

2.

2

1.



1.

2.

1

50

#DBCAAC

#623F23

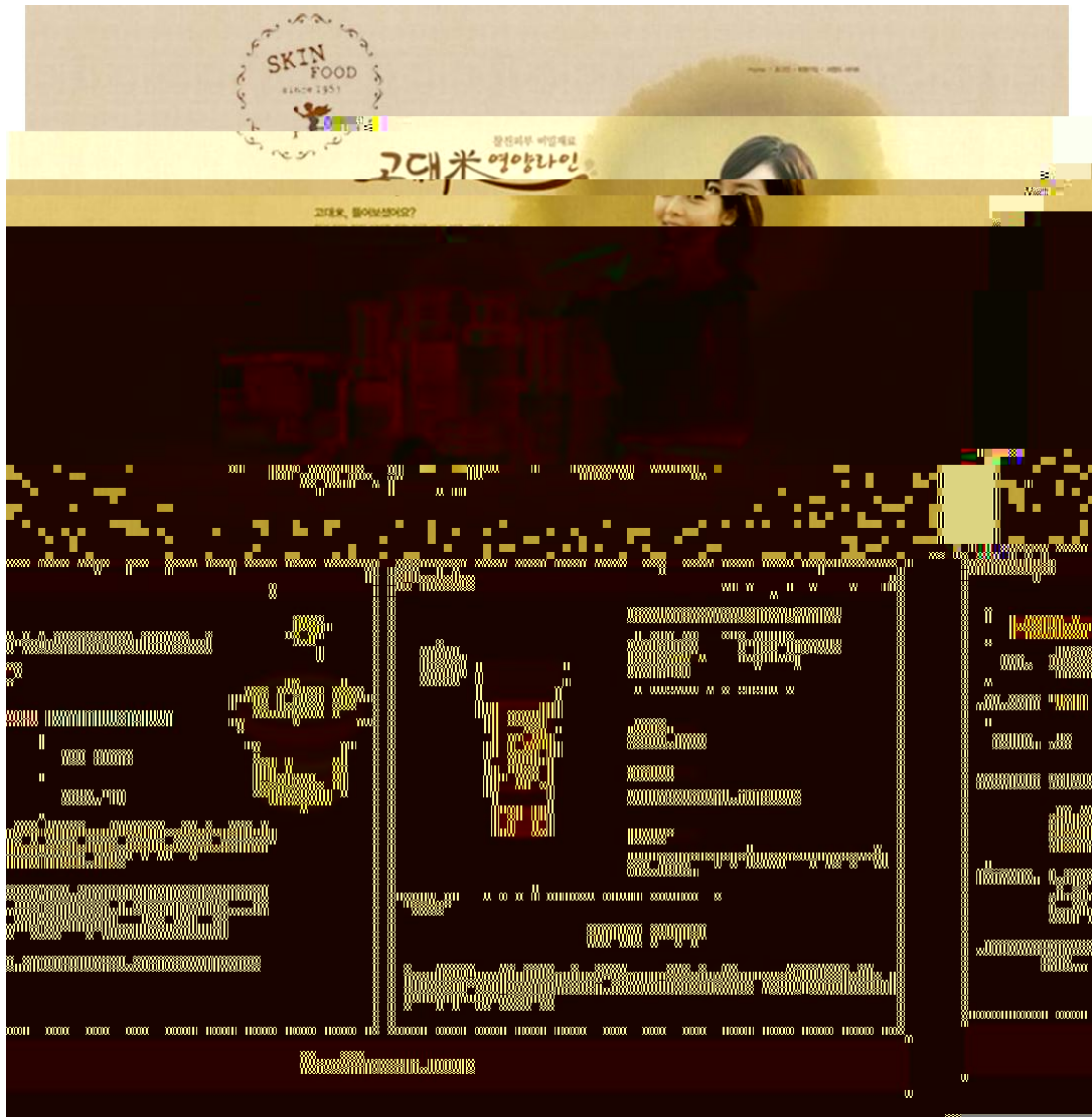



2

9

K

2

7 8

0 2010

P

CS6.0

D

CS6

3

60

4

( 2-17)

2-17

(10 )	10	5	6S
			5
LOGO	13	2	
		3	
		2	2
	9	2	3 2
		2	
	5	3	2
	5	1	3
	12	2	LOGO 5
		3	
(90 )		2	
	10		2 1
		3 2	3
	20	5	2 2
		6	
	6	K	1
		2	
		1	2
	10	5	5
	100		

18.

2-18

1

01.

18

01 .

4

-1.

-1.

. /

01 .

4

24.

27.

29.

31.

24.

1

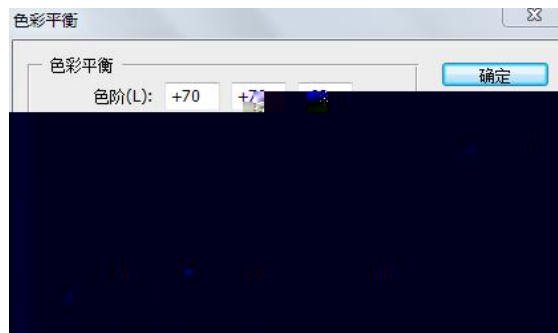

1

27.

2

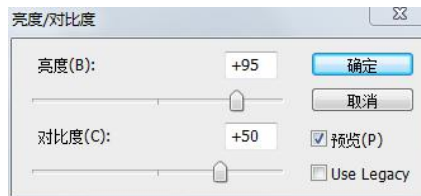

2

29.

3

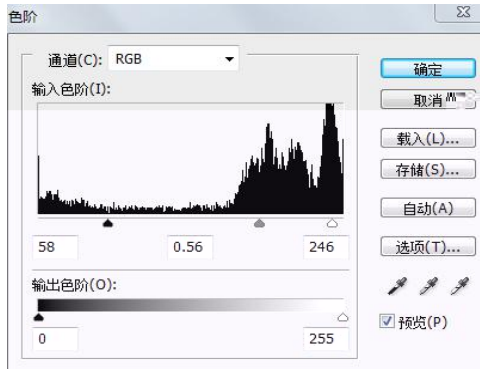

3

29. . 24. 27.  
31. 01. .

B

4

12

2

16

2

4



4

K

2

P 7 8 0 2010  
CS6.0 D CS6

3

60

4

( 2-18)

2-18

(10 )	10	5	6S
			5
(90 )	L	12	2 3
			2 1
	B	16	4 4
			2 3
		14	2 2
		4	2 2
		8	2 2 2
		16	3 3
		12	2 10
	8	K 2 2	
		2 2	
	100		

19.

2-19

1

.TTF

1

700\*450

350

110

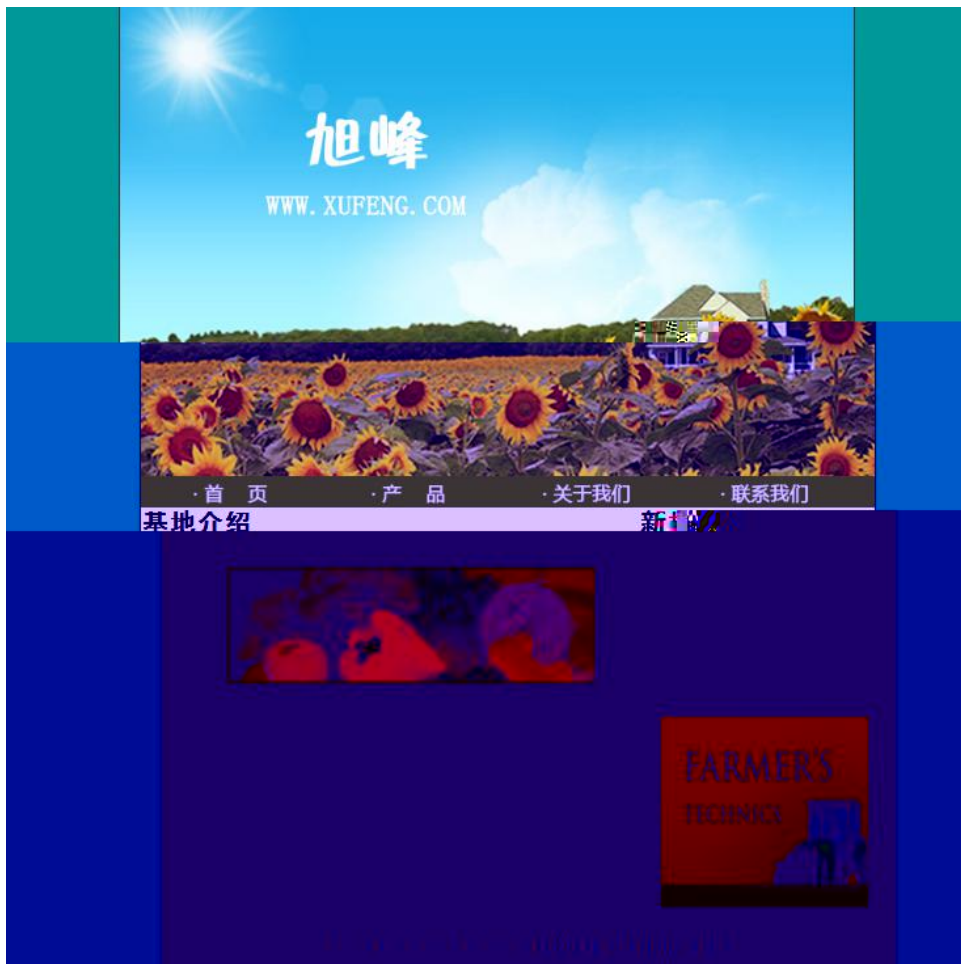

1

2 4

170 30

1.

2.

3.

4.

· PRODUCT

2

1

CSS

.

CSS

14

1.5

1

14

24

2

.

.

.

.

#009999

K

2

7 8

0 2010

P

CS6.0

D

CS6



2-19

			6S			
(10 )	10	5				
				5		
(90 )	B	13	3	2	2	
			2	2	2	
		4	2	2		
		12	3			
		6		1		
		10	5		5	
	CSS	17		5		
			6			
		16	2	2		
		4	2		2	
	8	K		2		
		2	2			
	100					

20.

2-20

1

1- 6 400\*300

#000000

#FF0000

B 1 B 2

6 2 3

200\*150 1

1 #1E6E87 150 20

#1E6E87 50 20

K



1

2

P 7 8 0 2010  
CS6.0 D CS6

3

60

4

( 2-20)

2-20

(10 )	10	5	6S
			5
	10	3	4
		3	
	18	1	2
	8	2	2
		2	2
	22	5	5 2 3 5
		5	2
(90 )	18	3	9
		3	3
	6		3
		3	
	8	K	2
			2
		2	2
	100		

1. 3-1

1  
1

200

2

4

T

T

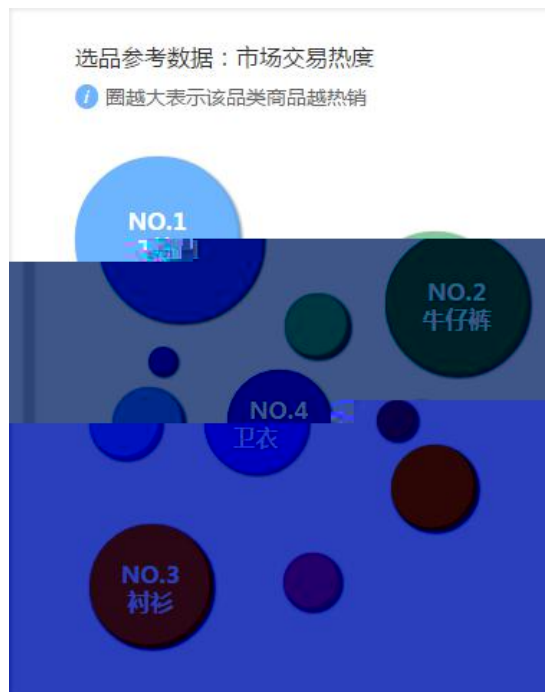

3

The screenshot displays a procurement system interface with a table of purchase quantity ranges and unit prices. The table is organized into rows for different items, with columns for quantity ranges and corresponding unit prices. The items listed include 'T恤' (T-shirt) and '牛仔裤' (jeans). The unit prices decrease as the purchase quantity increases.

Item	Quantity Range	Unit Price
T恤	1-1000件	195元/件
	1001-2000件	190元/件
	2001-3000件	185元/件
	3001-4000件	180元/件
	4001-5000件	175元/件
T恤	5000件以上	170元/件
	1-1000件	160元/件
	1001-2000件	155元/件
	2001-3000件	150元/件
T恤	3001-4000件	145元/件
	4001-5000件	140元/件
	5000件以上	135元/件
	1-1000件	270元/件
牛仔裤	1001-2000件	265元/件
	2001-3000件	260元/件

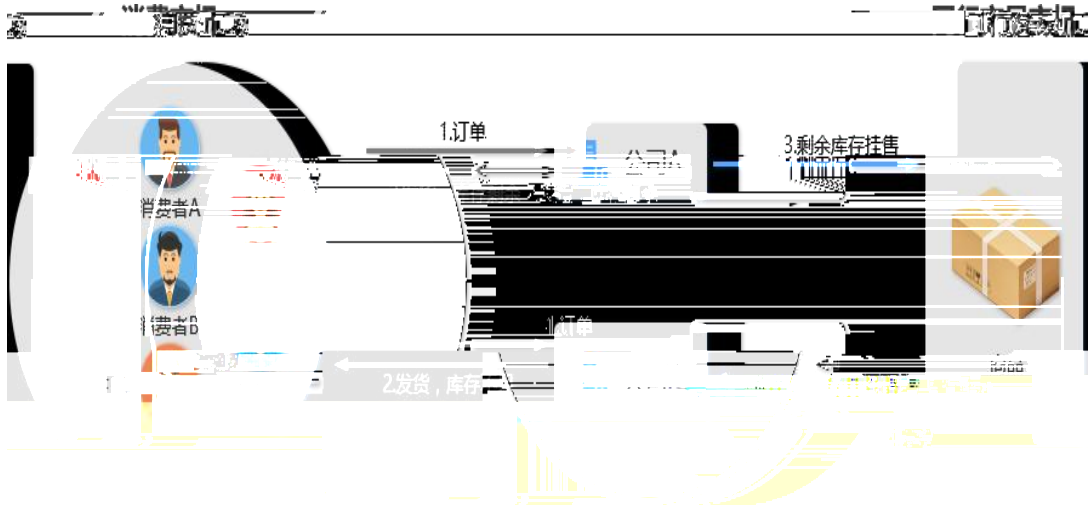

5

APP

6

200

1

2

	172. 16. 0. 131/	
		48
	3	
	1	

3

90

10	10	6S 3 /3 /4	
90	10	A 2 2 2 4	
	10	5 5	
	10	5 2 3	
	APP	5 10	
	15	5 10	
	10	5 5	
	10	5 3 2	
	10	5 5	
	100		



2.

3-2

1  
1

200

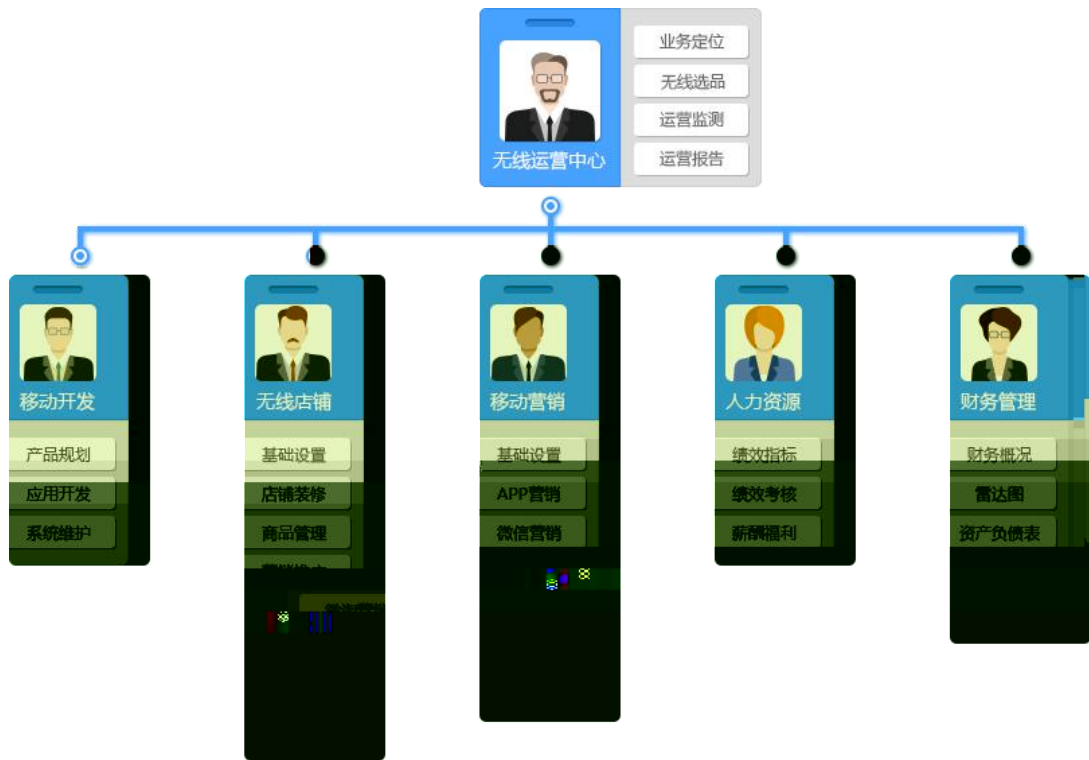

2

4

T

T

选品参考数据：市场交易热度

 圈越大表示该品类商品越热销

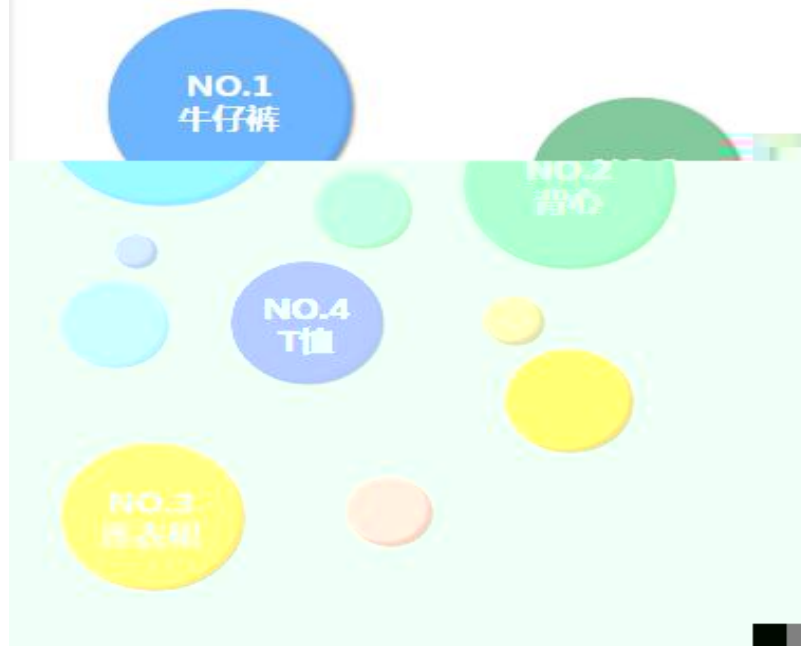



4)

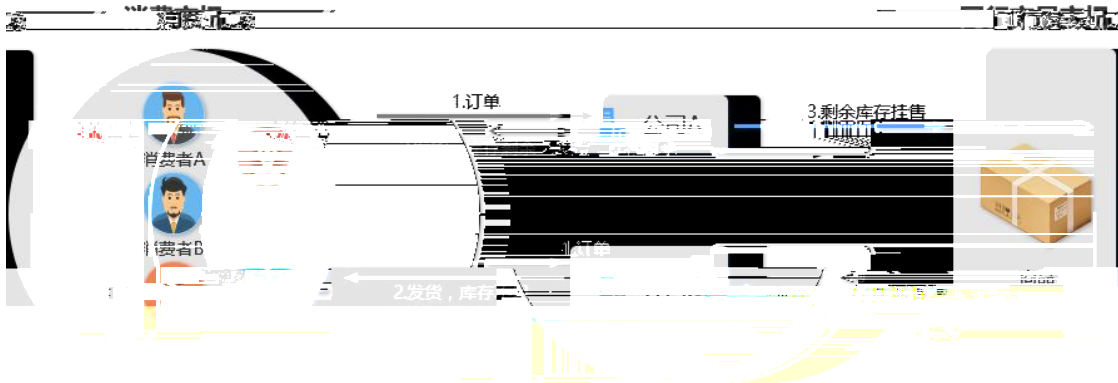

5

APP

6

200

1

9

3-2

10	10	6S 3 /3 /4	
90			
		10	A 2 2 2 4
		10	5 5
		10	5 2 3
	APP	15	5 10
		15	5 10
		10	5 5
		10	5 3 2
		10	5 5
		100	

3.

3-3

1  
1

200

2

4

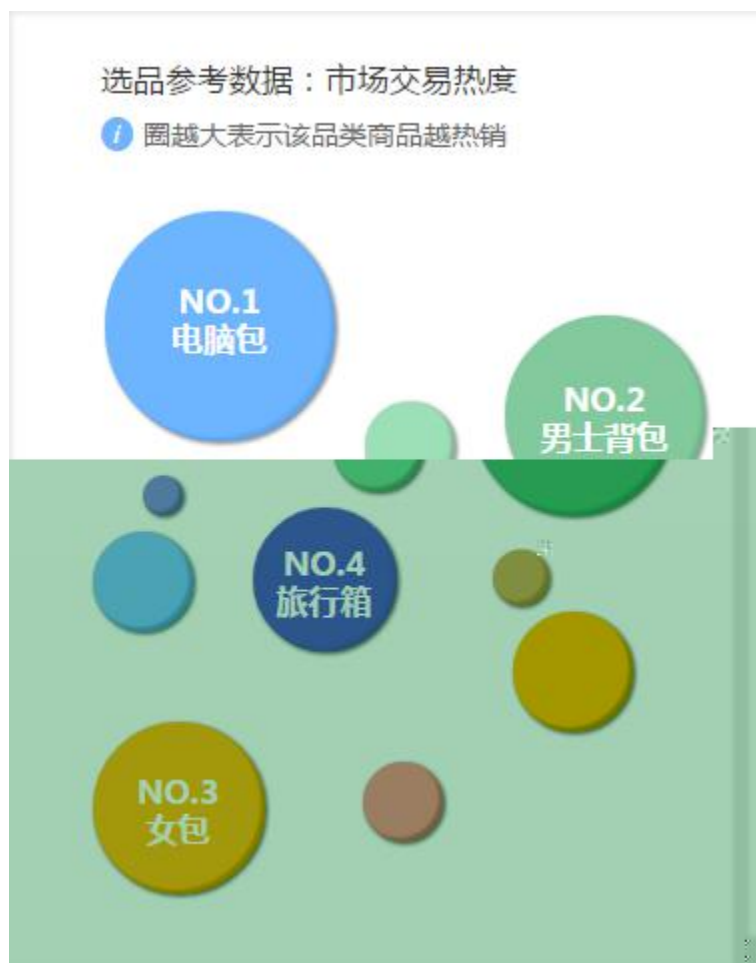

3

The screenshot displays a procurement system interface with a list of items. The items are categorized into '电脑包' (Computer Bag), '女包' (Women's Bag), and '男士背包' (Men's Backpack). Each item has a list of purchase quantity ranges and their corresponding unit prices.

Item Category	Quantity Range	Unit Price
电脑包	1-1000个	100元/个
	1001-2000个	95元/个
	2001-3000个	90元/个
	3001-4000个	85元/个
女包	1-1000个	300元/个
	1001-2000个	295元/个
	2001-3000个	290元/个
	5000个以上	275元/个
男士背包	1-1000个	150元/个
	1001-2000个	145元/个

4

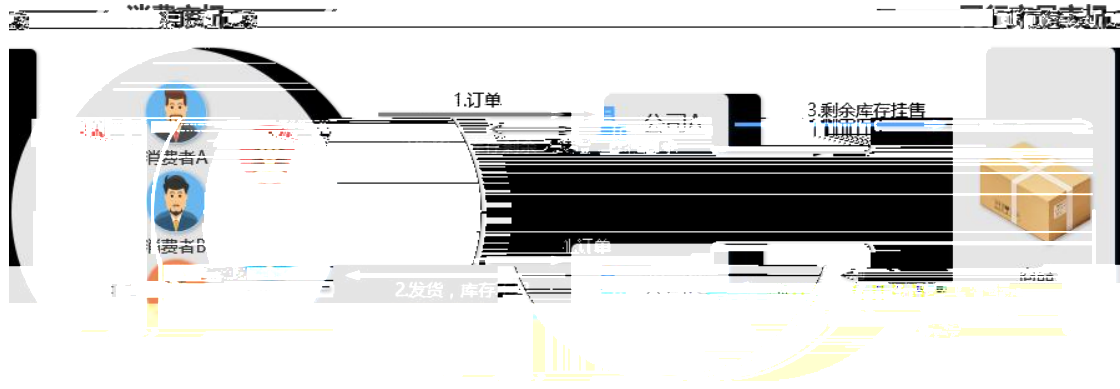

5

APP

6

200

1

2

	172.16.0.131/	
		48
		3
		1

3

90

4

3-3



3-3

10	10	6S 3 /3 /4	
90			
		10	A 2 2 2 4
		10	5 5
		10	5 2 3
	APP	15	5 10
		15	5 10
		10	5 5
		10	5 3 2
		10	5 5
		100	

4. 3-4

1  
1

200

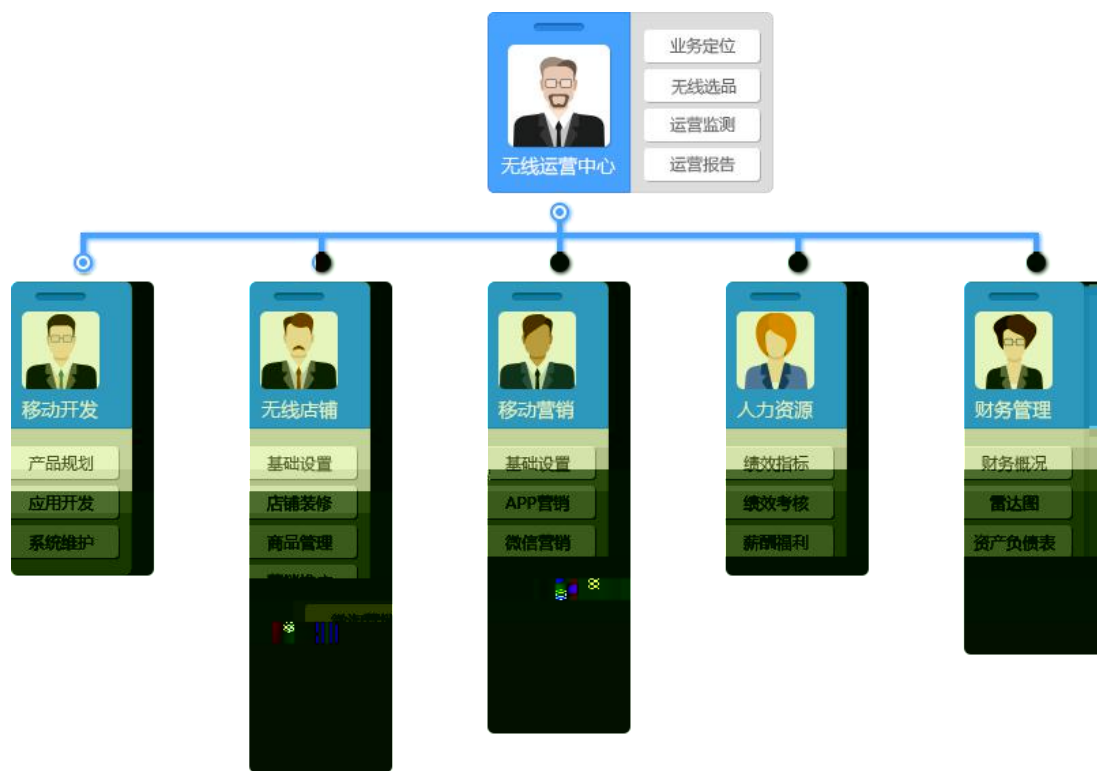

2

4

选品参考数据：市场交易热度

 圈越大表示该品类商品越热销



采购量	1-1000个	1001-2000个	2001-3000个	3001-4000个	4001-5000个	5000个以上
采购量	1-1000个	1001-2000个	2001-3000个	3001-4000个	4001-5000个	5000个以上
33元/个	34元/个	33元/个	33元/个	33元/个	33元/个	33元/个
采购量	1-1000个	1001-2000个	2001-3000个	3001-4000个	4001-5000个	5000个以上
110元/个	109元/个	108元/个	107元/个	106元/个	105元/个	105元/个
采购量	1-1000个	1001-2000个	2001-3000个	3001-4000个	4001-5000个	5000个以上
117元/个	116元/个	115元/个	114元/个	113元/个	112元/个	111元/个
采购量	1-1000个	1001-2000个	2001-3000个	3001-4000个	4001-5000个	5000个以上
110元/个	109元/个	108元/个	107元/个	106元/个	105元/个	105元/个

4



3-4

10	10	6S 3 /3 /4		
90	10	A	2 2 2 4	
		10	5	
			5	
	10	5		
		2		
		3		
	APP	15	5 10	
		15	5 10	
		10	5 5	
		10	5 3 2	
	10	5 5		
	100			

5. 3-5

1  
1

200

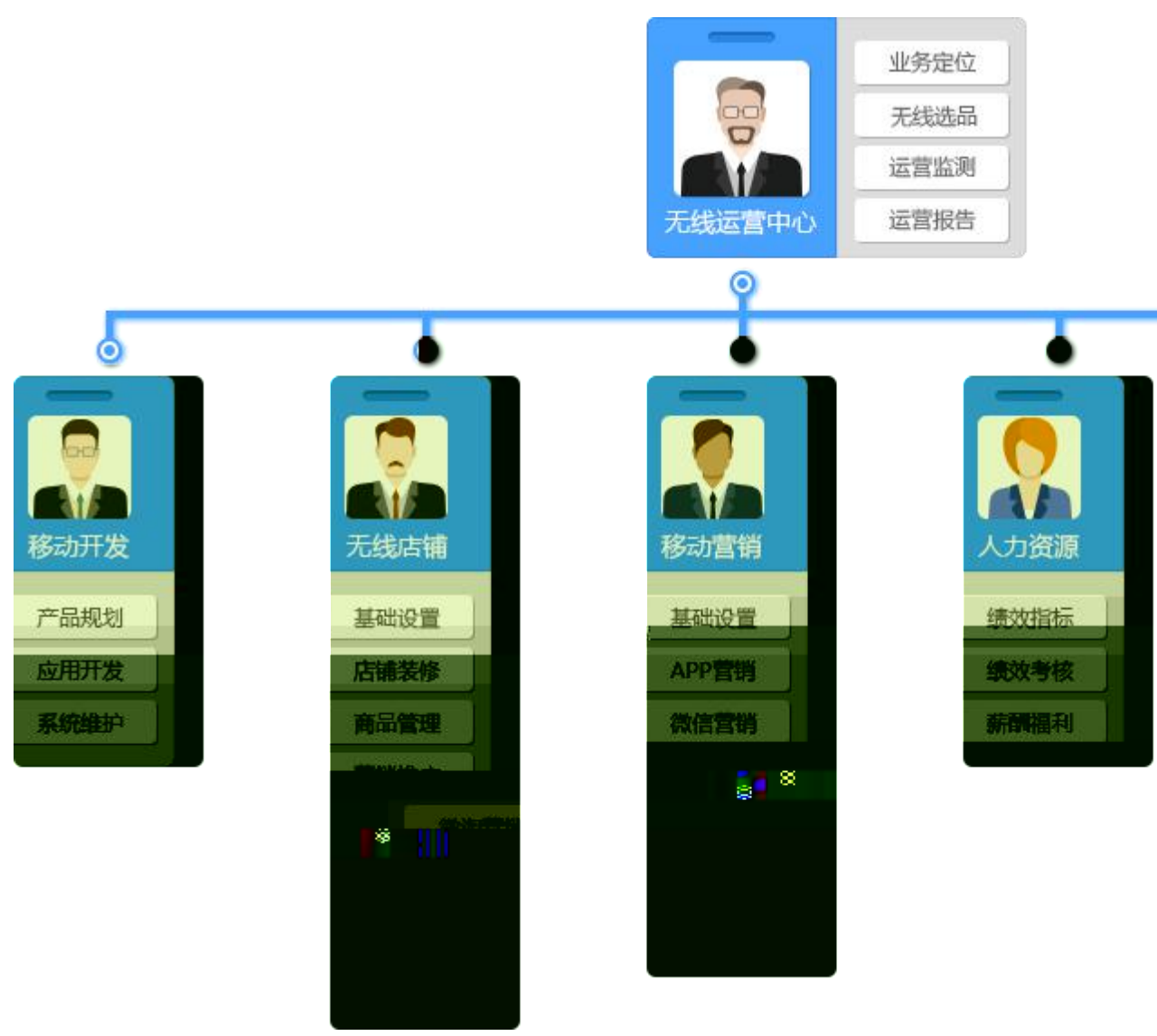

2





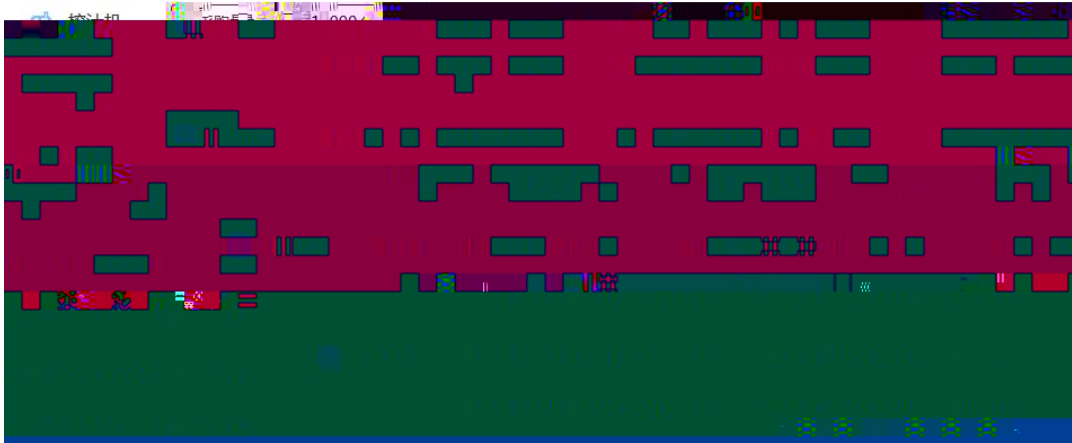

4

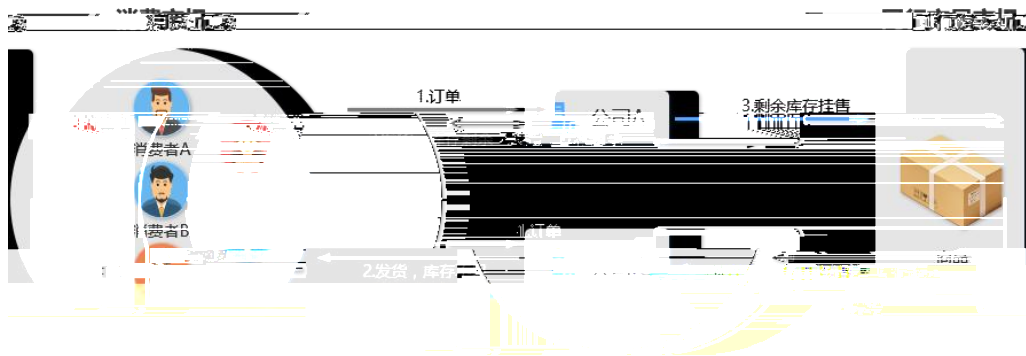

5

APP

6

200

2

	172. 16. 0. 131/	
	48	
	3 1	

3

90

4

3-5

10	10	6S 3 /3 /4	
90			
		10	A 2 2 2 4
		10	5 5
		10	5 2 3
	APP	15	5 10
		15	5 10
		10	5 5
		10	5 3 2
		10	5 5
		100	

6. 3-6

1  
1

200

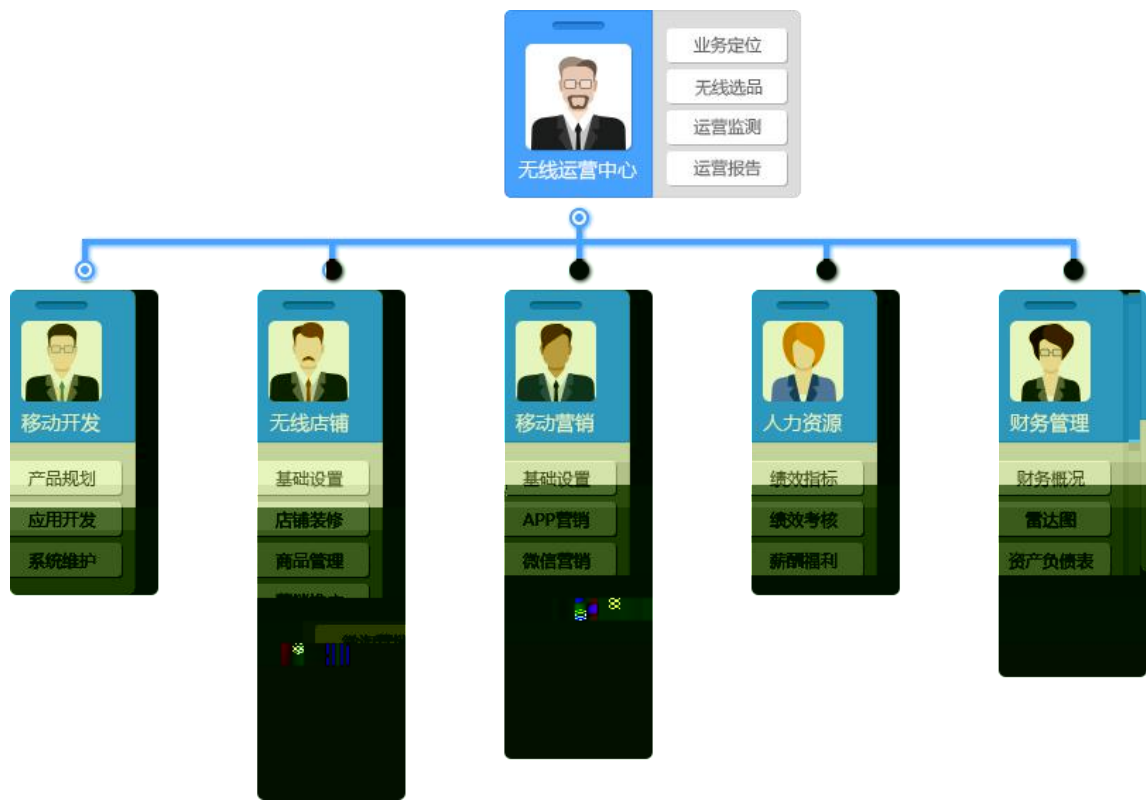

2

4

### 选品参考数据：市场交易热度

 圈越大表示该品类商品越热销

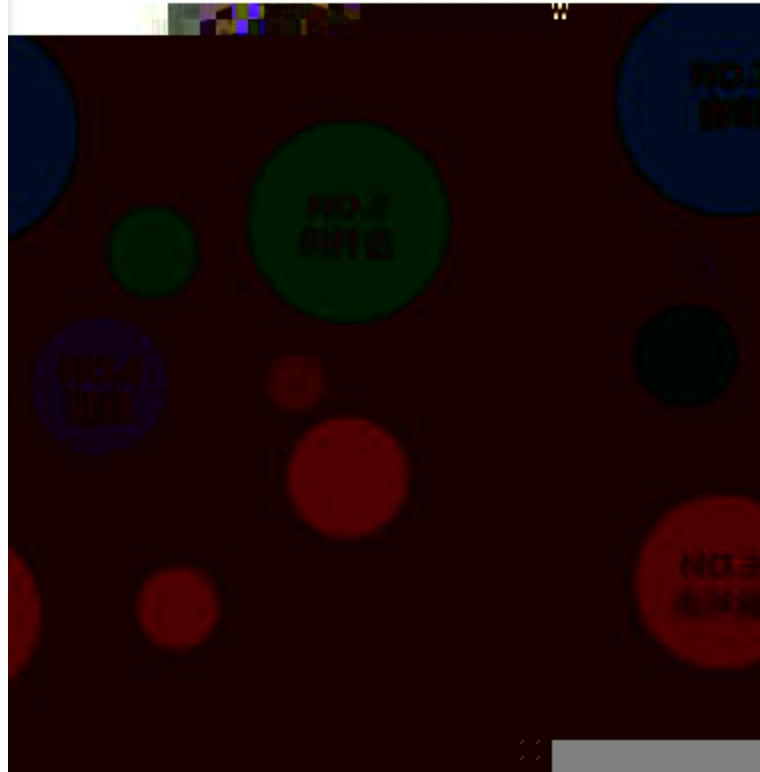

套 290元/套	采购量 1-1000套 300元/套	采购量 1001-2000套 275元/套	采购量 2001-3000套 250元/套
上 275元/套	采购量 3001-4000套 285元/套	采购量 4001-5000套 280元/套	采购量 5000套以上 275元/套
床 440元/床	蚕丝被 采购量 1-1000床 450元/床	采购量 1001-2000床 445元/床	采购量 2001-3000床 440元/床
1000床以上 425元/床	采购量 3001-4000床 435元/床	采购量 4001-5000床 430元/床	采购量 5000床以上 425元/床
1-3000米 190元/米	窗帘 采购量 1-1000米 200元/米	采购量 1001-2000米 195元/米	采购量 2001-3000米 190元/米
3000米以上 185元/米	采购量 3001-4000米 190元/米	采购量 4001-5000米 185元/米	采购量 5000米以上 180元/米

4

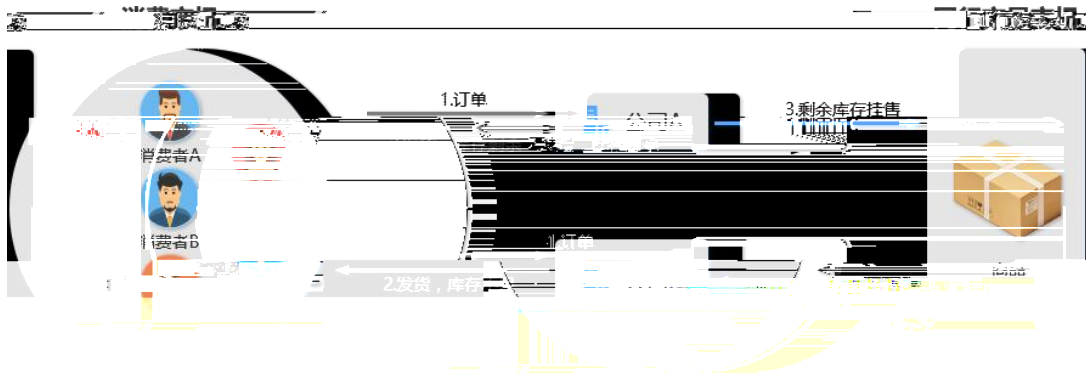

5

APP

6

200

1

2

	172.16.0.131/	
		48
		3
		1

3

90

4

3-6

3-6



7. 3-7

1  
1

200

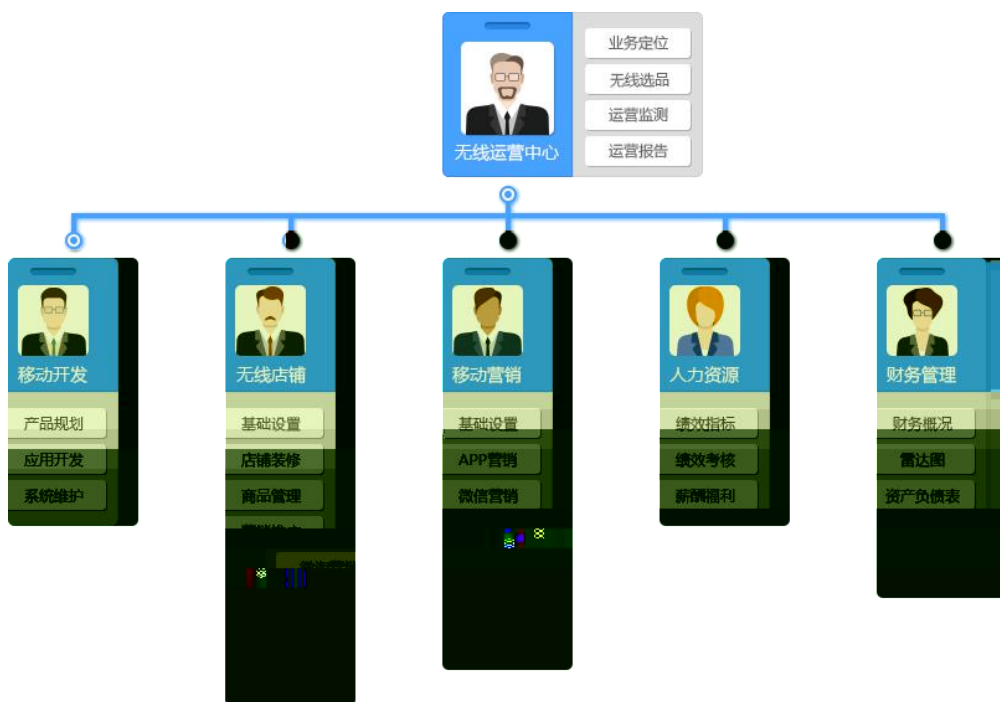

2

4

选品参考数据：市场交易热度

 圈越大表示该品类商品越热销



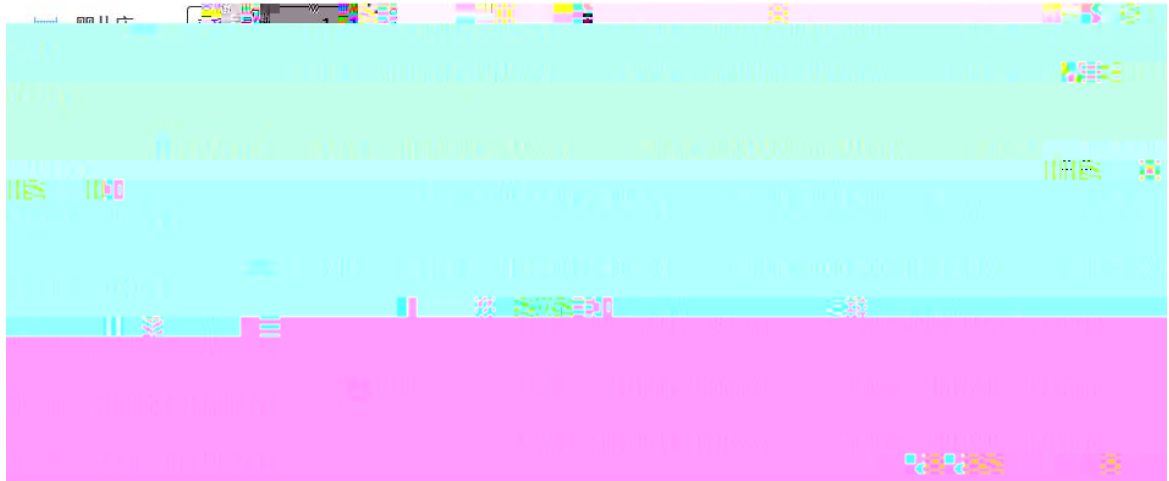

4

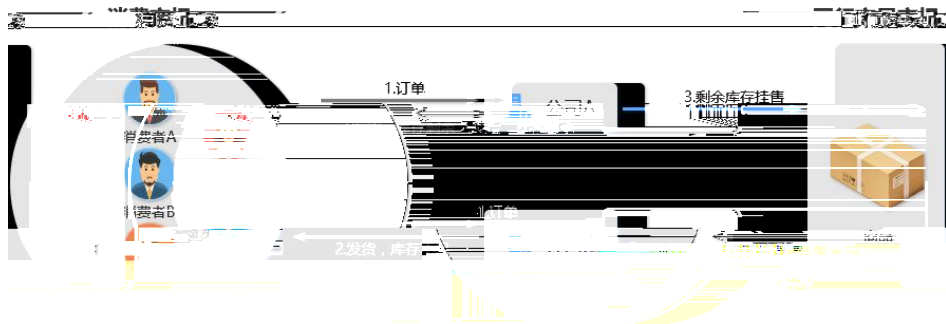

5

APP

6

200

2

	172. 16. 0. 131/	
		48
	3 1	

3

90

4

3-7

3-7

10	10	6S	
		3 /3 /4	
90			
		10	2 A 2 2 4
		10	5
			5
		10	5
			2
			3
	APP	15	5 10
		15	5 10
		10	5 5
	10	5 3 2	
	10	5 5	
	100		

8.

3-8

1  
1

200

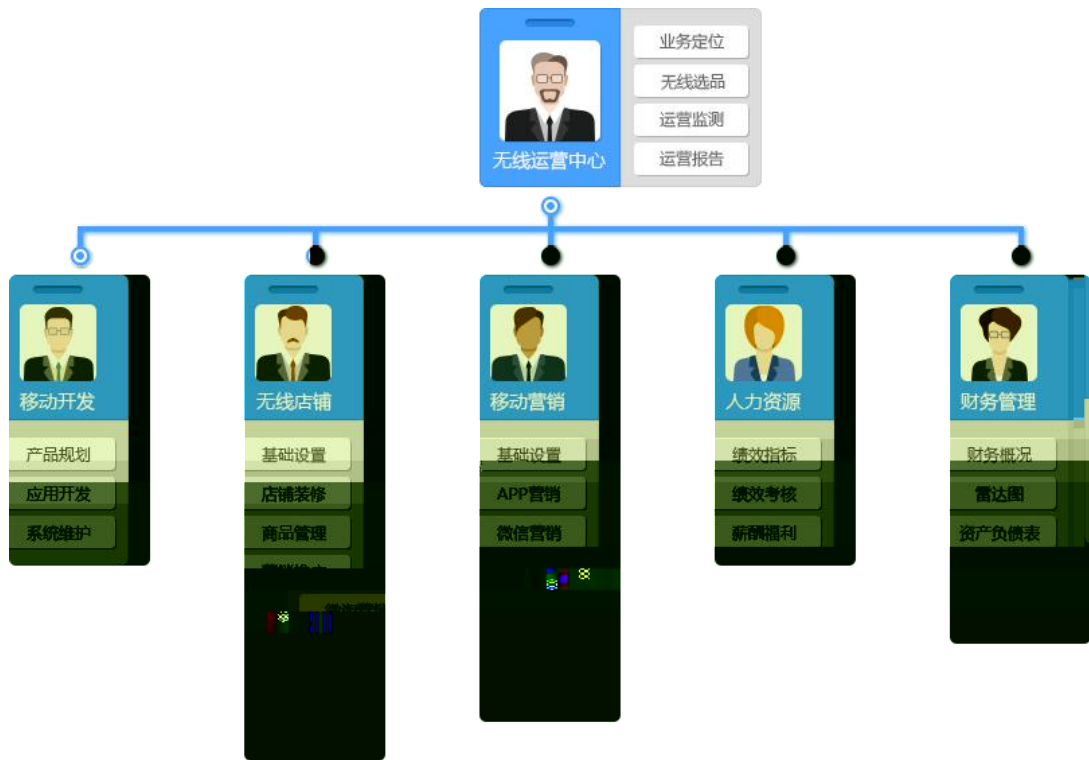

2

4

选品参考数据：市场交易热度

! 圈越大表示该品类商品越热销

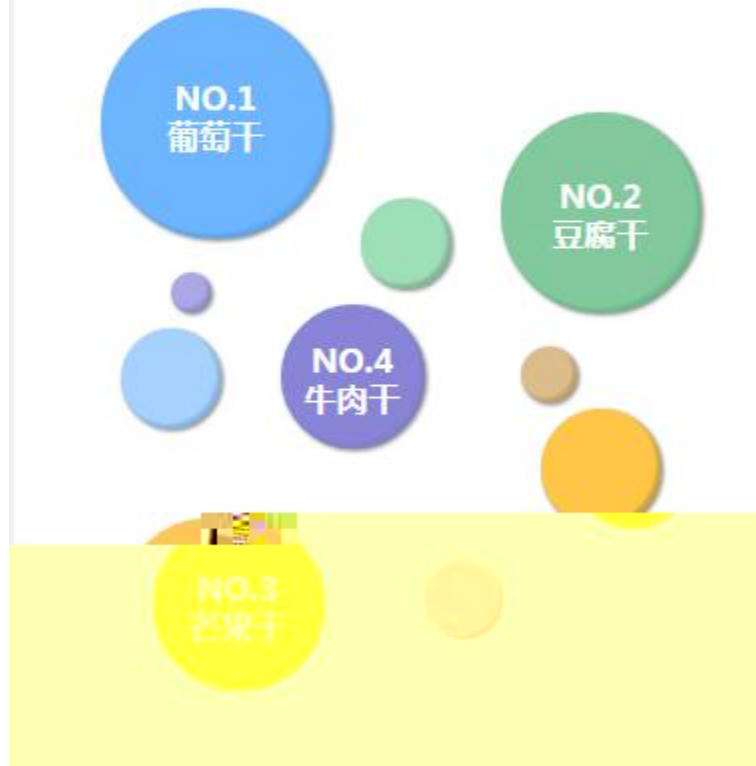

10箱 340元/箱	采购量 1-1000箱 330元/箱	采购量 1001-2000箱 345元/箱	采购量 2001-3000箱 350元/箱
以上 325元/箱	采购量 3001-4000箱 335元/箱	采购量 4001-5000箱 330元/箱	采购量 5000箱以上 320元/箱
10箱 90元/箱	采购量 1-1000箱 100元/箱	采购量 1001-2000箱 95元/箱	采购量 2001-3000箱 90元/箱
以上 85元/箱	采购量 3001-4000箱 85元/箱	采购量 4001-5000箱 80元/箱	采购量 5000箱以上 75元/箱
10箱 110元/箱	采购量 1-1000箱 125元/箱	采购量 1001-2000箱 120元/箱	采购量 2001-3000箱 115元/箱
以上 105元/箱	采购量 3001-4000箱 105元/箱	采购量 4001-5000箱 100元/箱	采购量 5000箱以上 95元/箱

4

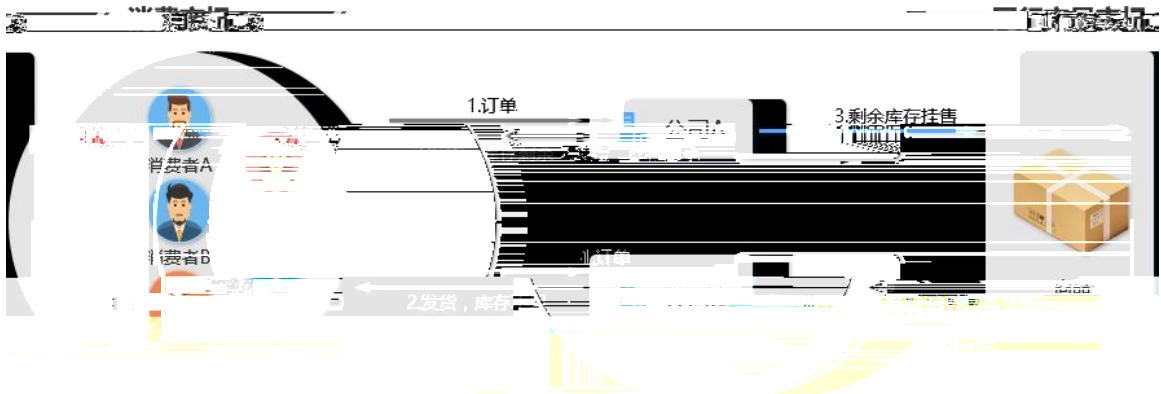

5

APP

6

200

1



2

	172.16.0.131/	
	48	
	3 1	

3

90

4

3-8

3-8

10	10		6S 3 /3 /4
90		10	A 2 2 2 4
		10	5 5
		10	5 2 3
	APP	15	5 10
		15	5 10
		10	5 5
		10	5 3 2
		10	5 5
		100	

9. 3-9

1  
1

200

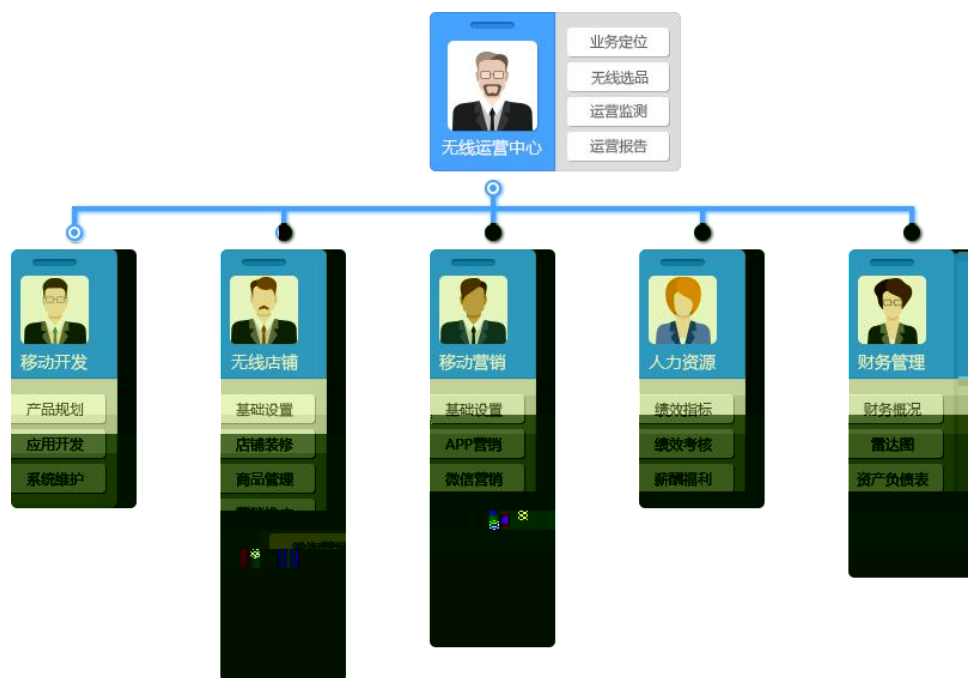

2

4

选品参考数据：市场交易热度

 圈越大表示该品类商品越热销





4

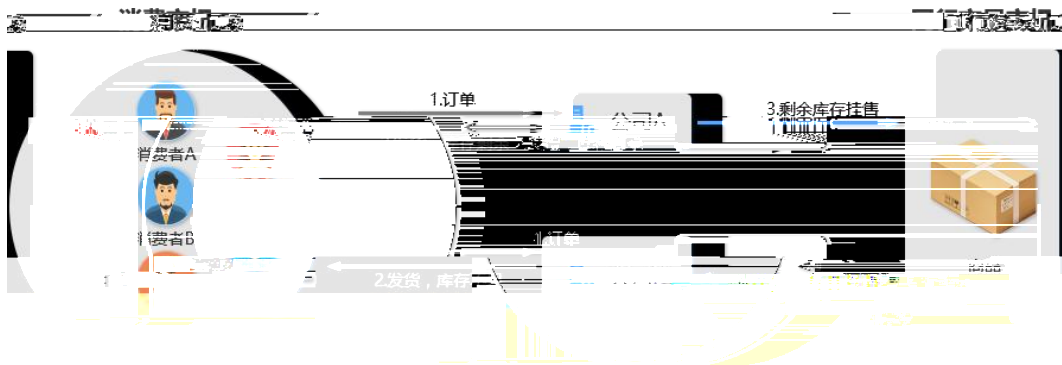

5

APP

6

200

1

2

	172. 16. 0. 131/	
	48	
	3 1	

3

90

4

3-9

3-9

10	10		6S 3 /3 /4
90		10	A 2 2 2 4
		10	5 5
		10	5 2 3
	APP	15	5 10
		15	5 10
		10	5 5
		10	5 3 2
		10	5 5
		100	

10. 3-10

1  
1)

200

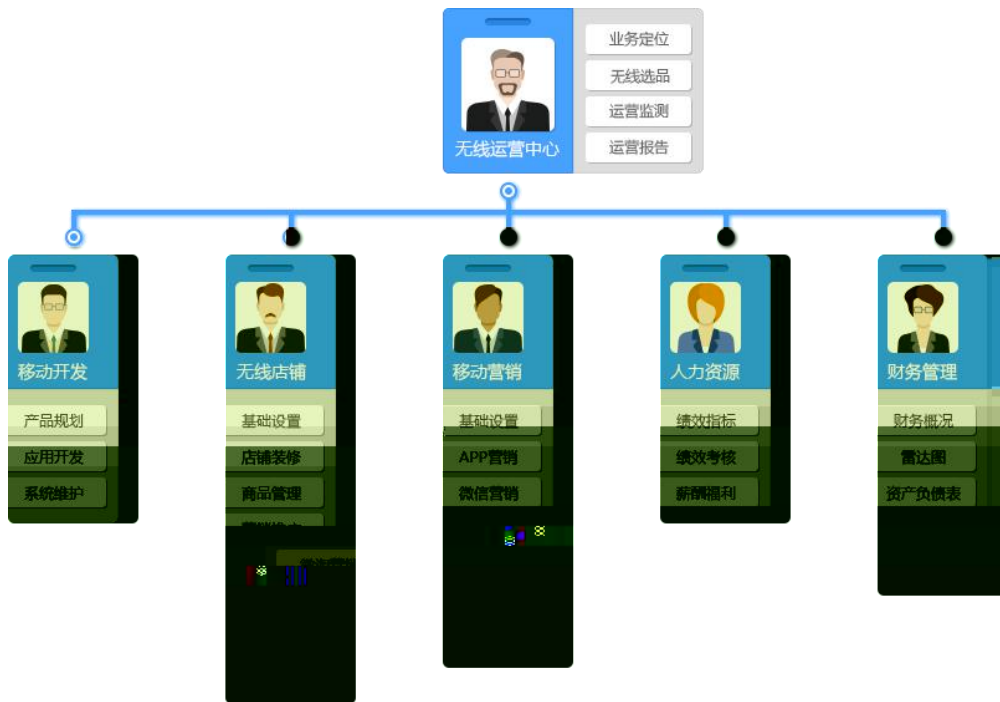

2)

4



### 选品参考数据：市场交易热度

 圈越大表示该品类商品越热销





4)

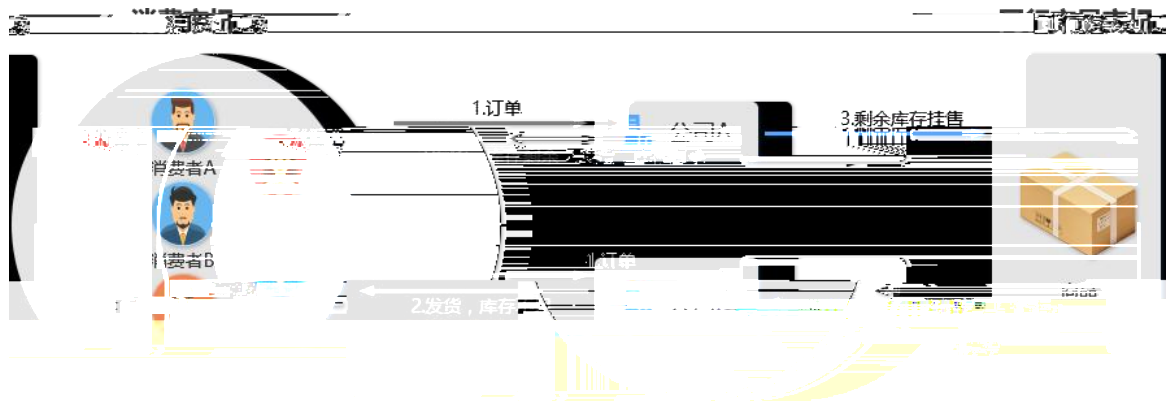

5

APP

6

2

	172. 16. 0. 131/	
	48	
	3 1	

3

90

4

10	10	6S 3 /3 /4	
90	10	A 2 2 2 4	
	10	5 5	
	10	5 2 3	
	APP	5 10	
	15	5 10	
	10	5 5	
	10	5 3 2	
	10	5 5	
	100		

11.

(10 )	10	/4 /6 /10	0
(90 )	10	120*120	
		0 /4 /6 /8 /10	
	5	50	
		0 /1 /2 /3 /4 /5	
	5		
		0 /1 /2 /3 /4 /5	
	5	1 2	2
	20	150 618	
		0 /5 /10 /15/20	
	20	1	
	200		
	0 /5 /10 /15/20		
3G	5		
	20		
		0 /5 /10 /15/20	
	100		

12. 3-12

1

1

2

3

:

(10 )	10	/4 /6 /10	0	
(90 )	10	120*120 0 /4 /6 /8 /10		
	5	50 0 /1 /2 /3 /4 /5		
	5	0 /1 /2 /3 /4 /5		
	5	1 2	2	
		150 618 0 /5 /10 /15/20		
	20	1 200 0 /5 /10 /15/20		
	3G	5		
		20	0 /5 /10 /15/20	
	100			



13. 3-13

1

1

2

3 :

4

5 6.18 11

1

11 6.18

6

1

200

7 3G 10 3G

8

2

7 8 0 2007 P

CS6.0

GOOGLE48

://172.16.0.131/ /

3

(10 )	10	/4 /6 /10	0	
(90 )	10	120*120 0 /4 /6 /8 /10		
	5	50 0 /1 /2 /3 /4 /5		
	5	0 /1 /2 /3 /4 /5		
	5	1 2	2	
		150 618 0 /5 /10 /15/20		
	20	1 200 0 /5 /10 /15/20		
	3G	5		
		20	0 /5 /10 /15/20	
	100			

14. 3-14

1

1

2

3 :

4

5 6.18 11

1

11 6.18

6

1

200

7 3G 10 3G

8

2

7 8 0 2007 P

CS6.0 GOOGLE48

://172.16.0.131/ /

3

90

(10 )	10	/4 /6 /10	0
(90 )	10	120*120	
		0 /4 /6 /8 /10	
	5	50	
		0 /1 /2 /3 /4 /5	
	5		
		0 /1 /2 /3 /4 /5	
	5	1 2	2
	20	150 618	
	0 /5 /10 /15/20		
20	1		
	200		
	0 /5 /10 /15/20		
3G	5		
	20		
		0 /5 /10 /15/20	
	100		

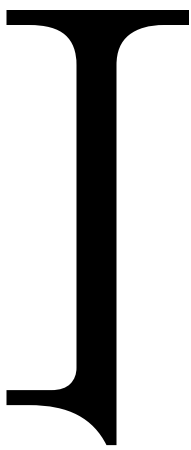

15.

3-15

1

1

2

3

:

4

5

6.18 11

1

11 6.18

6

1

200

7 3G

10

3G

8

2

7

8

0

2007

P

(10 )	10	/4 /6 /10	0
(90 )	10	120*120	
		0 /4 /6 /8 /10	
	5	50	
		0 /1 /2 /3 /4 /5	
	5		
		0 /1 /2 /3 /4 /5	
	5	1 2	2
	20	150 618	
		0 /5 /10 /15/20	
	20	1	
	200		
	0 /5 /10 /15/20		
3G	5		
	20		
		0 /5 /10 /15/20	
	100		

16. 3-16

1

1

2

3 :

4

5 6.18 11

1

11 6.18

6

1

200

7 3G 10 3G

8

2

7 8 0 2007 P

CS6.0

GOOGLE48

://172.16.0.131/ /

3

90

(10 )	10	/4 /6 /10	0
(90 )	10	120*120	
		0 /4 /6 /8 /10	
	5	50	
		0 /1 /2 /3 /4 /5	
	5		
		0 /1 /2 /3 /4 /5	
	5	1 2	2
	20	150 618	
		0 /5 /10 /15/20	
	20	1	
	200		
	0 /5 /10 /15/20		
3G	5		
	20		
		0 /5 /10 /15/20	
	100		



17. 3-17

1

1

2

3 :

4

5 6.18 11

1

11 6.18

6

1

200

7 3G 10 3G

8

2

7 8 0 2007 P

CS6.0 GOOGLE48

://172.16.0.131/ /

3

90

(10 )	10	/4 /6 /10	0	
(90 )	10	120*120 0 /4 /6 /8 /10		
	5	50 0 /1 /2 /3 /4 /5		
	5	0 /1 /2 /3 /4 /5		
	5	1	2	2
		20	150 618 0 /5 /10 /15/20	
		20	1 200 0 /5 /10 /15/20	
	3G	5		
		20	0 /5 /10 /15/20	
		100		

18. 3-18

1

1

2

3 :

4

5 6.18 11

1

11 6.18

6

1

200

7 3G 10 3G

8

2

7 8 0 2007 P

CS6.0

GOOGLE48

://172.16.0.131/ /

3

90

(10 )	10	/4 /6 /10	0
(90 )	10	120*120	
		0 /4 /6 /8 /10	
	5	50	
		0 /1 /2 /3 /4 /5	
	5		
		0 /1 /2 /3 /4 /5	
	5	1 2	2
	20	150 618	
		0 /5 /10 /15/20	
	20	1	
	200		
	0 /5 /10 /15/20		
3G	5		
	20		
		0 /5 /10 /15/20	
	100		

19. 3-19

1

1

2

3 :

4

5 6.18 11

1

11 6.18

6

1

200

7 3G 10 3G

8

2

7 8 0 2007 P

CS6.0 GOOGLE48

:://172.16.0.131/ /

3

90

(10 )	10	/4 /6 /10	0
(90 )	10	120*120 0 /4 /6 /8 /10	
	5	50 0 /1 /2 /3 /4 /5	
	5	0 /1 /2 /3 /4 /5	
	5	1 2	2
	20	150 618 0 /5 /10 /15/20	
	20	1 200 0 /5 /10 /15/20	
	3G	5	
		20	0 /5 /10 /15/20
	100		

20. 3-20

1

1

2

3 :

4

5 6.18 11

1

11 6.18

6

1

200

7 3G 10 3G

8

2

7 8 0 2007 P

CS6.0

GOOGLE48

://172.16.0.131/

/

3

90

(10 )	10	/4 /6 /10	0
(90 )	10	120*120	
		0 /4 /6 /8 /10	
	5	50	
		0 /1 /2 /3 /4 /5	
	5		
		0 /1 /2 /3 /4 /5	
	5	1 2	2
	20	150 618	
		0 /5 /10 /15/20	
	20	1	
	200		
	0 /5 /10 /15/20		
3G	5		
	20		
		0 /5 /10 /15/20	
	100		



1. 4-1

1

1

7

1000

.

.

2010 4

5000

+

+

+

2

a.

---

b.

50

---

---

---

c.

10

---

d.

50

1		

e.

100

1		
2		
3		

f.

400

1			
2			
3			

g.

h.

3

2

7 8 0 2007 H S

3

60

4

( 4-1)

4-1

	10	6S 0 /3 /5 0 /3 /5	
	5		
	5	1	10
	5	2 1	
	5		2
	10	3 10 1	
	10	4 6 20	
	40	1	
	40	4 36	
	10	40 1	
	10		2
		8	
	10		2 8
	100		

2.

4-2

1

1

[www.168gld.com](http://www.168gld.com)

1997 3 20

500

2017

2500

2

d.

50

1		

e.

100

1		
2		
3		

f.

400

1			
2			
3			

g.

h.

3

2

3

60

4

( 4-2)

4-2

	10	6S 0 /3 /5 0 /3 /5	
	5		
	5	1	10
	5	2 1	
	5		2
	10	1	3 10 1
	10	1	4 6 20
	40	40 1	4 36
	10		8 2
10		2 8	
	100		

3. 4-3

1  
1

www.hnaijia.cn

1200

2014 03 18

49

17

4508

2

a.

---

b.

50

---

---

c.

10

---

d.

50

1		

e.

100

1		

2		
3		

f.

400

1			
2			
3			

g.

h.

3

2

7 8 0 2007 H S

3

60

4

( 4-3)



4-3

	10	6S 0 /3 /5 0 /3 /5	
	5		
	5	1	10
	5	2 1	
	5		2
	10	1	3 10 1 4 6 20
	40	40 1	4 36
	10		2 8
	10		2 8
	100		

4. 4-4

1  
1

www.hnxffs.com

1996

AAA	2011		21
		58	5088
336		35	50
			66
20		165	

	CAD		2		6
		7			
	41				

		1996		
	2008	ISO9001		ISO14001
2011				
( )				

2

a.

---

b.

50

---



---



---

c. 10

d.

50

1		

e.

100

1		
2		
3		

f.

400

1		
2		
3		

g.

h.

3

2

7 8 0 2007 H S

3

60

4

( 4-4)

**4-4**

	10	6S 0 /3 /5 0 /3 /5	
	5		
	5	1	10
	5	2 1	
	5		2 3 10 1
	10	1	4 6 20
	40	40 1	4 36
	10		2 8
	10		2 8
	100		

5. 4-5

1  
1

www.cschanglong.com 1985  
2007

2007  
A 2008  
2012

2011 fs.changsha.cn  
2012

2

a.

---

b.

50

---

---

c.

10

---

d.

50

1		

e.

100

1		
2		
3		

f.

400

1			
2			
3			

g.

h.

3

2

3

60

4

( 4-5)

4-5

	10	6S 0 /3 /5 0 /3 /5	
	5		
	5	10 1	
	5	2 1	
	5	3 10 1 2	
	10	4 6 20 1	
	40	4 36 40 1	
	10	8 2	
	10	2 8	
	100		

6. 4-6

1  
1

<http://www.and169.com>

2006

5000

2

a.

---

b.

50

---

---

---

c.

10

---

d.

50

1		

e.

100



1		
2		
3		

f.

400

1			
2			
3			

g.

h.

3

2

7 8 0 2007 H S

3

60

4

( 4-6)

4-6

	10	6S 0 /3 /5 0 /3 /5	
	5		
	5	1	10
	5	2 1	
	5		2
	10	3 10 1	
	10	4 6 20	
	40	1	
	40	4 36	
	10	40 1	
	10		2
		8	
	10		2 8
	100		

7. 4-7

1  
1

<http://www.csqstx.com>

-

2

a.

---

b.

50

---

---

---

c.

10

---

d.

50

1		

e.

100

1		
2		
3		

f.

400

1			
2			
3			

g.

h.

3

2

7 8 0 2007 H S

3

60

4

( 4-7)

4-7

	10	6S 0 /3 /5 0 /3 /5	
	5		
	5	1	10
	5	2 1	
	5		2
	10	1	3 10 1
	10	1	4 6 20
	40	40 1	4 36
	10		8 2
10		2 8	
	100		

8. 4-8

1  
1

<http://www.cstycb.com>

2016

10

2

a.

---

b.

50

---

---

c.

10

---

d.

50

1		

e.

100

1		
2		
3		

f.

400

1			
2			
3			

g.

h.

3

2

7 8 0 2007 H S

3

60

4

( 4-8)

4-8

	10	6S 0 /3 /5 0 /3 /5	
	5		
	5	1	10
	5	2 1	
	5		2
	10	1	3 10 1 4 6 20
	40	40 1	4 36
	10		2 8
	10		2 8
	100		



9. 4-9

1  
1

2016 3 22

3000

20

2

a.

---

b. 50

---

---

---

c. 10

---

d.

50

1		

e.

100

1		
2		
3		

f.

400

1			
2			
3			

g.

h.

3

2

7 8 0 2007 H S

3

60

4

( 4-9

4-9

	10	6S 0 /3 /5 0 /3 /5	
	5		
	5	1	10
	5	2	1
	5	2	3 10 1
	10	20 1	4 6
	40	40 1	4 36
	10		8 2
	10		2 8
	100		

10. 4-10

1  
1

www.bidanxi.com 2010 2012

3

21

50

2

a.

---

b.

50

---

---

c.

10

---

d.

50

1		

e.

100

1		
2		
3		

f.

400

1			
2			
3			

g.

h.

3

2

7 8 0 2007 H S

3

4

( 4-10)

4-10

	10	6S 0 /3 /5 0 /3 /5	
	5		
	5	1	10
	5	2	1
	5	2	3 10 1
	10	20 1	4 6
	40	40 1	4 36
	10		8 2
	10		2 8
	100		

1. 5-1

1

1

58

1150 520 76900 9 30-  
12 30 14 00-18 30 19 30-23 00

2

3

2

7 8 0 2010

3

60

4

( 5-1)

5-1

10	10	◆	5	600	
		◆	20 1		
			5		
	10	◆		2	1.
		◆		2	200
		◆		3	1
		◆	3		2.
		◆	5	4	30000 1
	20	1.	2		3
		2.			20
		10	2		1
		20			4.
90		◆	10		35
		◆		10	5.
	40	◆	10		
		◆		10	
		◆			1
			1-4		
	20	◆	4		
			1 5 20		
			100		



2. 5-2

1

1

68

780

405

77030

9 30-12 00 13 00-18:00 19:00- 22 30

2

:

2

7 8 0 2010

3

60

4

( 5-2)

5-2

10	10	◆	5	600	
		◆	20 1		
			5		
	10	◆		2	1.
		◆		2	200
		◆		3	1
		◆	3		2.
		◆	5	4	30000 1
	20	1.	2		3
		2.			20
		10	2		1
		20			4.
90		◆	10		35
		◆		10	5.
	40	◆	10		
		◆		10	
		◆			1
			1-4		
	20	◆	4		
			1 5 20		
			100		

3. 5-3

1

1

48

980

268

300000

10 00-14 00 16 00-23 00

2

:

2

7 8

0 2010

3

60

4

( 5-3)

5-3

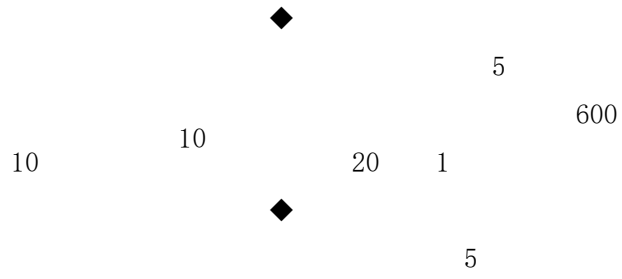

1.      200

1

2.

30000      1

3

20

1

4.

35

5.

1



4. 5-4

1

1

68

1600

560

38900

8 30-12 00 14 00-17

30 18 30-22 30

2

:

2

7 8 0 2010

3

60

4

( 5-4)

5-4

10	10	◆	5	600	
		◆	20 1		
			5		
	10	◆		2	1.
		◆		2	200
		◆		3	1
		◆	3		2.
		◆	5	4	30000 1
	20	1.	2		3
		2.			20
		10	2		1
		20			4.
90		◆	10		35
		◆		10	5.
	40	◆	10		
		◆		10	
		◆			1
			1-4		
	20	◆	4		
			1 5 20		
			100		

5. 5-5

1

1

T

145

1500

732

13500

9 30-12 30 14 00-18 30 19 30-23

00

2

:

2

7 8

0 2010

3

60

4

( 5-5)

5-5

10	10	◆	5	600	
		◆	20 1		
			5		
90	10	◆		2	1.
		◆		2	200
		◆		3	1
		◆		3	2.
			3		
	20	◆	5	4	30000 1
			1.	2	3
			2.		20
			10	2	1
			20		4.
	40	◆	10		35
		◆		10	5.
		◆	10		
		◆		10	
		◆			1
			1-4		
	20	◆	4		
			1	5	20
			100		



6. 5-6

1

1

2004

200

980

125

215000

9 30-12 30 14 00-18 30 19 30-23 00

2

:

2

7 8 0 2010

3

60

4

( 5-6)

5-6

10	10	◆	5	600	
		◆	20 1		
			5		
	10	◆		2	1.
		◆		2	200
		◆		3	1
		◆	3		2.
		◆	5	4	30000 1
	20	1.	2		3
		2.			20
		10	2		1
		20			4.
90		◆	10		35
		◆		10	5.
	40	◆	10		
		◆		10	
		◆			1
			1-4		
	20	◆	4		
			1 5 20		
			100		

7. 5-7

1

1

65

780

110

340000

10 00-14 00 16 00-23 00

2

:

2

7

8

0

2010

3

60

4

( 5-7)

5-7

10	10	◆	5	600	
		◆	20 1		
			5		
	10	◆		2	1.
		◆		2	200
		◆		3	1
		◆	3		2.
		◆	5	4	30000 1
	20	1.	2		3
		2.			20
		10	2		1
		20			4.
90		◆	10		35
		◆		10	5.
	40	◆	10		
		◆		10	
		◆			1
			1-4		
	20	◆	4		
			1 5 20		
			100		

8. 5-8

1

1

170

260

870

26100

9 30-12 00 13 00-18:00 19:00- 22 30

2

:

2

7 8

0 2010

3

60

4

( 5-8)

5-8

10	10	◆	5	600	
		◆	20 1		
			5		
	10	◆		2	1.
		◆		2	200
		◆		3	1
		◆	3		2.
		◆	5	4	30000 1
	20	1.	2		3
		2.			20
		10	2		1
		20			4.
90		◆	10		35
		◆		10	5.
	40	◆	10		
		◆		10	
		◆			1
			1-4		
	20	◆	4		
			1 5 20		
			100		

9. 5-9

1

1

80

980

280

52750

10 00-14 00 16 00-23

00

2

:

2

7 8

0 2010

3

60

4

( 5-9)





10. 5-10

1

1

78

170

240

15600

8 30-12 00 14 00-17 30 18

30-22 30

2

:

2

7 8

0 2010

3

60

4

( 5-10)

5-10

10	10	◆	5	600	
		◆	20 1		
			5		
90	10	◆		2	1.
		◆		2	200
		◆		3	1
		◆			2.
			3		
	20	◆	5	4	30000 1
			1.	2	3
			2.		20
			10	2	1
			20		4.
	40	◆	10		35
		◆		10	5.
		◆			
		◆	10	10	
		◆			1
			1-4		
	20	◆	4		
				1 5 20	
			100		

